



**OWNER'S MANUAL**

**ST1100**

**HONDA**



---

## IMPORTANT NOTICE

- **OPERATOR AND PASSENGER**

This motorcycle is designed to carry the operator and one passenger. Never exceed the maximum weight capacity as shown on the tyre information label.

- **ON-ROAD USE**

This motorcycle is designed to be used only on the road.

- **READ THIS OWNER'S MANUAL CAREFULLY**

Pay special attention to statements preceded by the following words:

**⚠ WARNING**

*Indicates a strong possibility of severe personal injury or death if instructions are not followed.*

**CAUTION:**

*Indicates a possibility of personal injury or equipment damage if instructions are not followed.*

**NOTE:** Gives helpful information.

This manual should be considered a permanent part of the motorcycle and should remain with the motorcycle when resold.



---

**HONDA PAN EUROPEAN  
ST1100  
OWNER'S MANUAL**

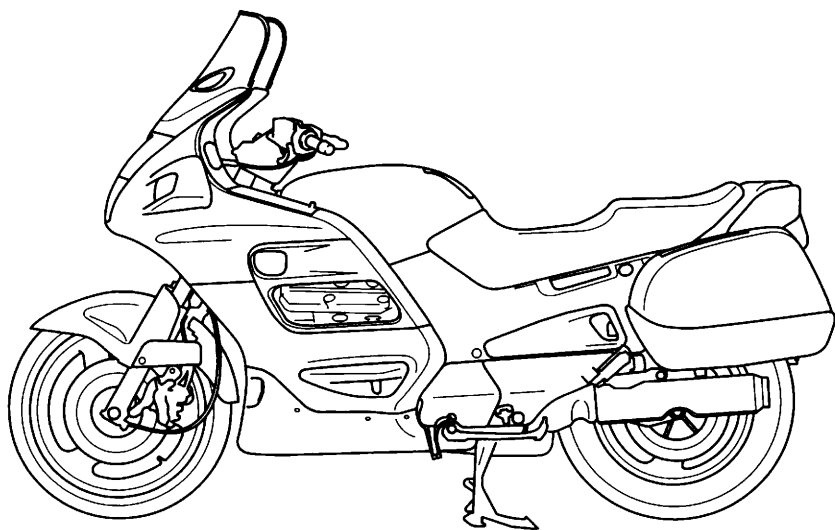

***All information in this publication is based on the latest production information available at the time of approval for printing. HONDA MOTOR CO., LTD. reserves the right to make changes at any time without notice and without incurring any obligation. No part of this publication may be reproduced without written permission.***

**© Honda Motor Co., Ltd 1996**

# WELCOME

---

The motorcycle presents you a challenge to master the machine, a challenge to adventure. You ride through the wind, linked to the road by a vehicle that responds to your commands as no other does. Unlike an automobile, there is no metal cage around you. Like an airplane, a pre-ride inspection and regular maintenance are essential to your safety. Your reward is freedom.

To meet the challenges safely, and to enjoy the adventure fully, you should become thoroughly familiar with this owner's manual **BEFORE YOU RIDE THE MOTORCYCLE.**

When service is required, remember that your Honda dealer knows your motorcycle best. If you have the required mechanical "know-how" and tools, your dealer can supply you with an official Honda Shop Manual to help you perform many maintenance and repair tasks.

Pleasant riding, and thank you for choosing a Honda!

- Following codes in this manual indicate each country.

Sales Name: Pan European

AR	Austria	IT	Italy
E	UK	N	Norway
ED	European direct sales Belguim Holland Portugal	SP	Spain
		SW	Switzerland
F	France		
FI	Finland		
G	Germany		

Sales Name: ST1100

U	Australia
---	-----------

- The specifications may vary with each local.
- Following words in this manual indicate each mechanism.
  - CBS: Combined Brake System
  - ABS: Anti-lock Brake System
  - TCS: Traction Control System

# CONTENTS

---

## OPERATION

Page		Page	
1	MOTORCYCLE SAFETY	38	Helmet Holders
1	Safe Riding Rules	38	Luggage Tie-Down Hooks
2	Protective Apparel	39	Document Compartment
3	Modifications	40	Digital Clock
4	Loading and Accessories	41	Saddlebags
		43	Fairing Pockets
		44	Rear view mirrors
7	PARTS LOCATION	45	Headlight Beam Adjustment
10	Instruments and Indicators	46	Accessory (ACC) Terminal
16	MAJOR COMPONENTS (Information you need to operate this motorcycle)	47	OPERATION
16	Rear Suspension	47	Pre-ride Inspection
18	Brakes	48	Starting the Engine
21	Clutch	49	Running-in
22	Coolant	52	Riding
24	Fuel	53	Braking
27	Engine Oil	58	Traction Control System (TCS)
29	Final Drive Oil	62	Parking
30	Tubeless Tyres	63	Anti-theft Tips
34	ESSENTIAL INDIVIDUAL COMPONENTS		
34	Ignition Switch		
35	Right Handlebar Controls		
36	Left Handlebar Controls		
37	FEATURES (Not required for operation)		
37	Steering Lock		
37	Seat		

# CONTENTS

---

## MAINTENANCE

Page		Page	
64	MAINTENANCE	84	FRAME/WHEELS/ BRAKES
65	Maintenance Schedule	84	Front Wheel Removal
67	Tool Kit	90	Rear Wheel Removal
68	Serial Numbers	93	Brake Pad Wear
68	Colour Label	94	Brake System Inspection
69	Maintenance Precau- tions	95	Side Stand
70	Cover Removal	96	ELECTRICAL
75	FILTERS/LUBRICATION	96	Battery
75	Engine Oil And Filter	98	Fuse Replacement
78	Air Cleaner	103	CLEANING
80	ENGINE	105	STORAGE GUIDE
80	Spark Plugs	105	Storage
82	Idle Speed	106	Removal From Storage
83	DRIVE TRAIN	107	SPECIFICATIONS
83	Final Drive Oil	110	NOISE EMISSION (AUSTRALIA ONLY)

# MOTORCYCLE SAFETY

---

## SAFE RIDING RULES

### WARNING

- ***Motorcycle riding requires special efforts on your part to ensure your safety. Know these requirements before you ride:***
1. Always make a pre-ride inspection (page 46) before you ride the motorcycle.  
You may prevent an accident or equipment damage.
  2. Many accidents involve inexperienced riders. Most states require a special motorcycle riding test or license. Make sure you are qualified before you ride. NEVER lend your motorcycle to an inexperienced rider.
  3. Many automobile/motorcycle accidents happen because the automobile driver does not “see” the motorcyclist.  
Make yourself conspicuous to help avoid the accident that wasn’t your fault:
    - Wear bright or reflective clothing.
    - Don’t ride in another motorist’s “blind spot.”
  4. Obey all national and local laws and regulations.
    - Excessive speed is a factor in many accidents. Obey the speed limits, and NEVER travel faster than conditions warrant.
    - Signal before you make a turn or lane change. Your size and maneuverability can surprise other motorists.
  5. Don’t let other motorists surprise you. Use extra caution at intersections, parking lot entrances and exits, and driveways.
  6. Keep both hands on the handlebars and both feet on the footpegs while riding. A passenger should hold on to the motorcycle or the operator with both hands and keep both feet on the passenger footpegs.

### CAUTION:

- ***Do not ride over curbs or rub the wheel against an obstacle, as wheel damage may result.***

# **MOTORCYCLE SAFETY**

---

## **PROTECTIVE APPAREL**

1. Most motorcycle accident fatalities are due to head injuries: ALWAYS wear a helmet. You should also wear a face shield or goggles as well as boots, gloves, and protective clothing. A passenger needs the same protection.
2. The exhaust system becomes hot during operation, and it remains hot for a while after stopping the engine. Be careful not to touch the exhaust system while it is hot. Wear clothing that fully covers your legs.
3. Do not wear loose clothing which could catch on the control levers, footpegs, or wheels.

---

## MODIFICATIONS

### **⚠ WARNING**

- ***Modification of the motorcycle, or removal of original equipment, may render the vehicle unsafe or illegal. Obey all federal, state and local equipment regulations.***

# MOTORCYCLE SAFETY

---

## LOADING AND ACCESSORIES

### **▲ WARNING**

- *To prevent an accident, use extreme care when adding and riding with accessories and cargo. Addition of accessories and cargo can reduce a motorcycle's stability, performance and safe operating speed. Never ride an accessory-equipped motorcycle at speeds above 130 km (80 mph). And remember that this 130 km (80 mph) limit may be reduced by installation of non-Honda accessories, improper loading, worn tires and overall motorcycle condition, poor road or weather conditions. These general guidelines may help you decide whether or how to equip your motorcycle, and how to load it safely.*

### Loading

The combined weight of the rider, passenger, cargo and additional accessories must not exceed the maximum weight capacity;

**201 kg (443 lbs)** ...without CBS/ABS/TCS (Except AR, SW)

**200 kg (441 lbs)** ...without CBS/ABS/TCS (AR, SW)

**191 kg (421 lbs)** ...with CBS/ABS/TCS (Except AR, SW)

**190 kg (419 lbs)** ...with CBS/ABS/TCS (AR, SW)

Cargo weight alone should not exceed 27 kg (60 lbs).

1. Keep cargo and accessory weight low and close to the center of the motorcycle. Load weight equally on both sides to minimize imbalance. As weight is located farther from the motorcycle's center of gravity, handling is proportionally affected.
2. Adjust tire pressure (page 31).
3. All cargo and accessories must be secure for stable handling. Recheck cargo security and accessory mounts frequently.

- 
4. Do not attach large, heavy items to the handlebars, fork, or fender. Unstable handling or slow steering response may result.
  5. Do not exceed the maximum weight capacity of Honda accessories.
    - Saddlebag: **9 kg (20 lbs) Each side**
    - Fairing pocket: **2 kg (4.5 lbs) Each side**
  6. The Honda fairing and saddlebag are designed for this motorcycle only. Do not install them on any other motorcycle.
  7. Do not store articles between fairing and motorcycle. They may interfere with steering causing loss of control.
  8. Do not use the handlebars to hold the motorcycle with a rope during transportation or the handlebars may be bent.

### **Accessories**

Genuine Honda accessories have been specifically designed for and tested on this motorcycle. Because the factory cannot test all other accessories, you are personally responsible for proper selection, installation, and use of non-Honda accessories.

Always follow the guidelines under Loading, and these:

1. Carefully inspect the accessory to make sure it does not obscure any lights, reduce ground clearance and banking angle, or limit suspension travel, steering travel or control operation.
2. Large fork-mounted fairings or windshields, or poorly designed or improperly mounted fairings can produce aerodynamic forces that cause unstable handling. Do not install fairings that decrease cooling air flow to the engine.

## **MOTORCYCLE SAFETY**

---

3. Accessories which alter your riding position by moving hands or feet away from controls may increase reaction time in an emergency.
4. Do not add electrical equipment that will exceed the motorcycle's electrical system capacity. A blown fuse could cause a dangerous loss of lights or engine power.
5. This motorcycle was not designed to pull a sidecar or trailer. Handling may be seriously impaired if so equipped.
6. Any modification of the cooling system may cause overheating and serious engine damage. Do not modify the radiator shrouds or install accessories which block or deflect air away from the radiator.

# PARTS LOCATION

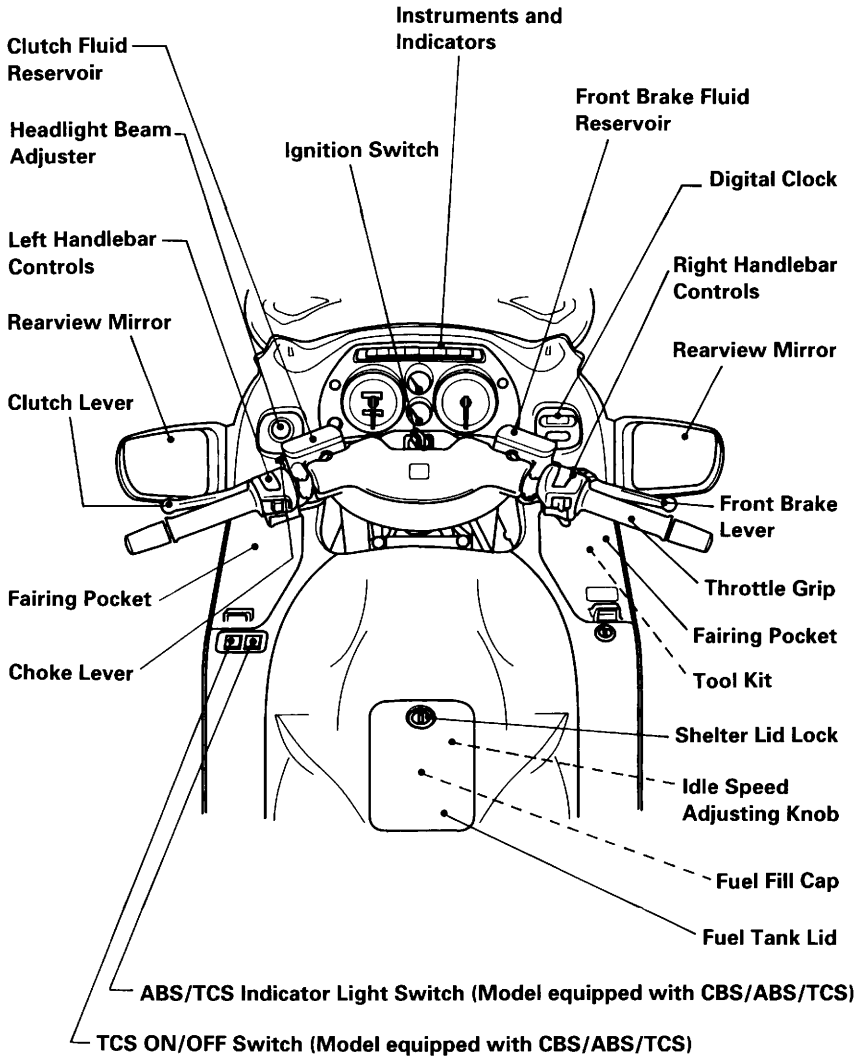

# PARTS LOCATION

---

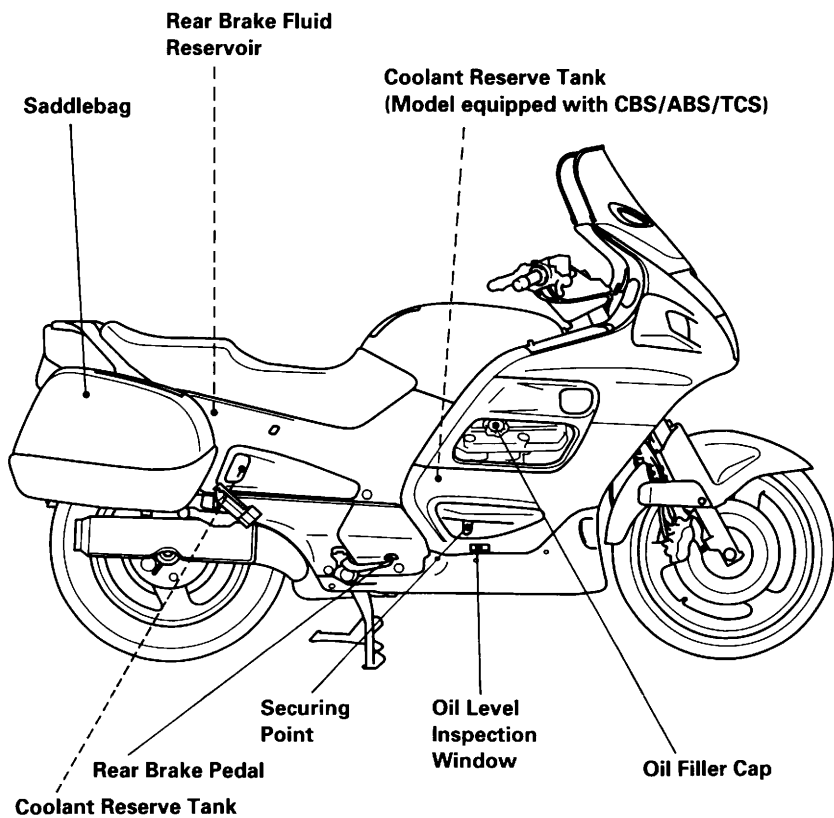

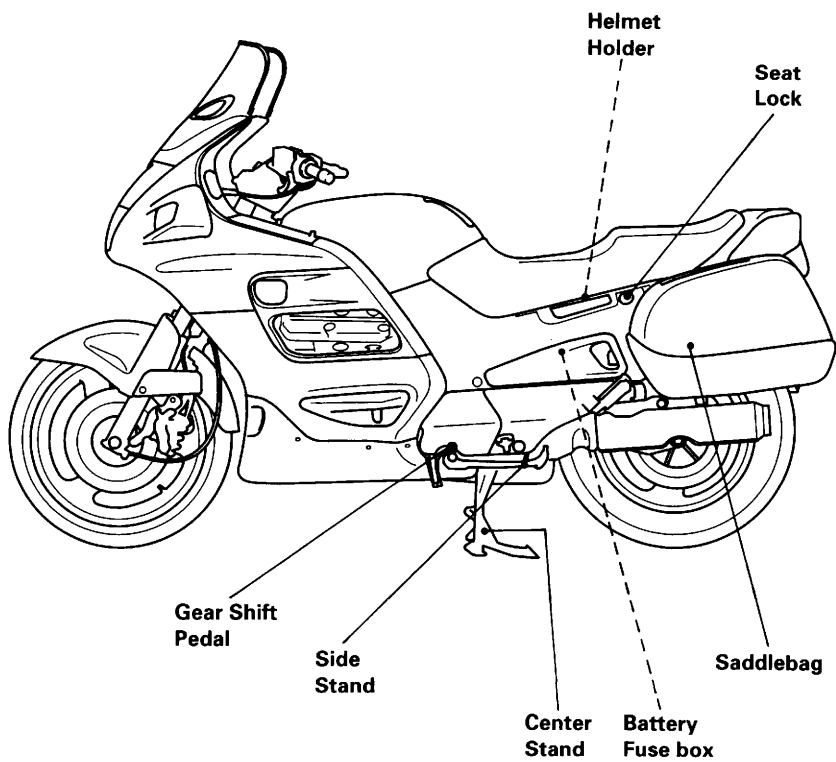

# PARTS LOCATION

## INSTRUMENTS AND INDICATORS

The indicators are incorporated in the instrument panel. Their functions are described on the following pages.

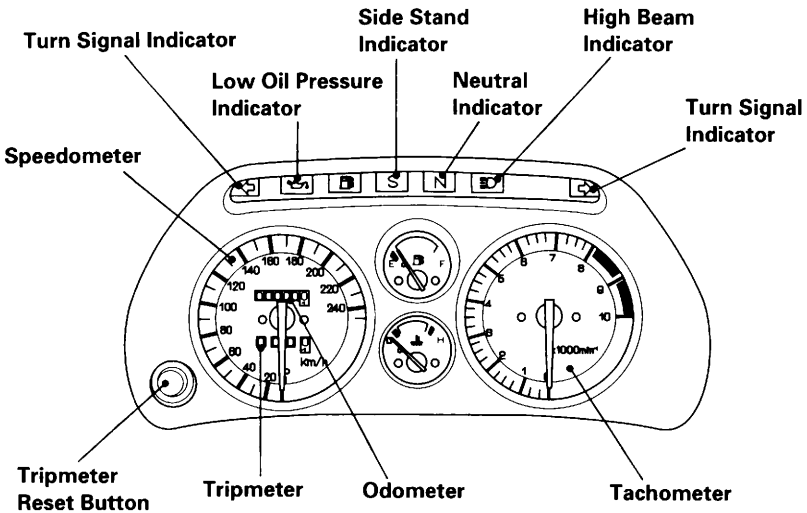

(For model equipped with CBS/ABS/TCS)

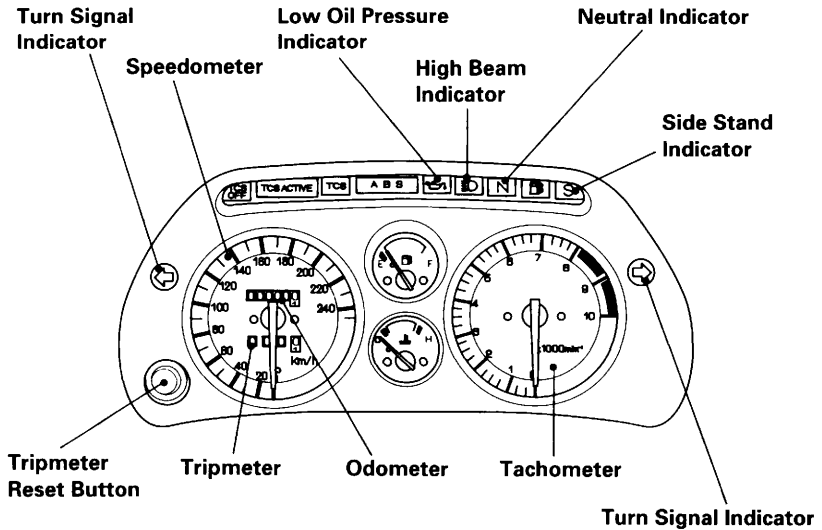

---

**Speedometer:** shows riding speed.

**Tachometer:** shows engine rpm.

Never allow the tachometer needle to enter the red zone, even after the engine has been broken in.

**CAUTION:**

- *The red zone indicates the maximum limits of engine speed and running the engine in the red zone may adversely affect its service life.*

**Turn Signal Indicators (green):** Flashes when the turn signal operates.

**Odometer:** Shows accumulated mileage.

**Tripmeter:** Shows mileage per trip.

**Tripmeter Reset Button:** Pushing the button resets the tripmeter to zero (0)

**High Beam Indicator (blue):** Lights when the headlight is on high beam.

**Neutral Indicator (green):** Lights when the transmission is in neutral.

**Low Oil Pressure Indicator (red):**

Lights when engine oil pressure is below the normal operating range. Should also light when the ignition switch is ON and the engine is not running. Should go off when the engine starts, except for occasional flickering at or near idling speed when the engine is warm.

**CAUTION:**

- *Running the engine with insufficient oil pressure may cause serious engine damage.*

**Side Stand Indicator (amber):**

Lights when the side stand is put down.

Before parking, check that the side stand is fully down; the light only indicates the side stand ignition cut-off system (page 47) is activated.

# PARTS LOCATION

---

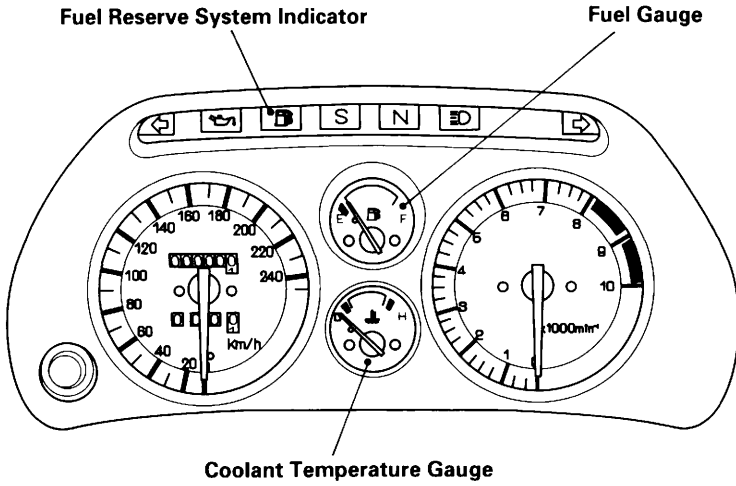

(For model equipped with CBS/ABS/TCS)

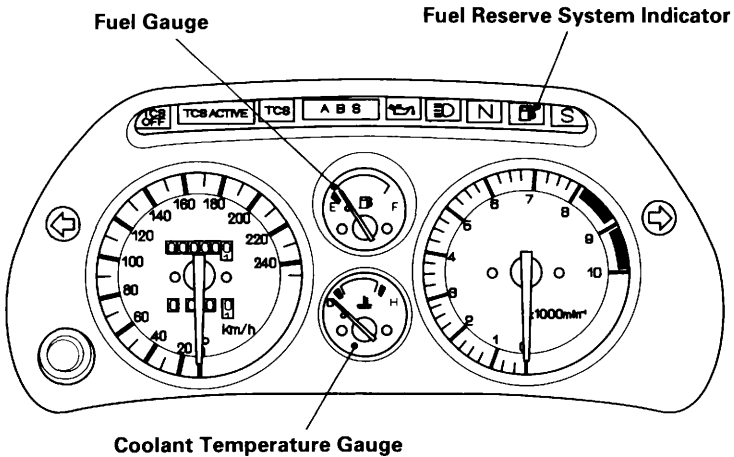

---

### **Fuel Reserve System Indicator:**

When this Indicator comes on while riding, there are about 5 liters (1.3 US gal, 1.1 Imp gal) left in the tank. Should also light for a few seconds and go off when the ignition switch is turned ON.

### **Fuel Gauge:**

The fuel gauge shows the approximate fuel supply available. At F (Full) there are 28 liters (7.4 US gal, 6.1 Imp gal), including the reserve supply.

When the gauge needle enters the red band, the fuel level is low and you should refill the tank as soon as possible. The amount of fuel left in the tank when the needle enters the red band is approximately 3.5 liters (0.9 US gal, 0.8 Imp gal)

### **Coolant Temperature Gauge:**

The normal operating temperature range is the zone between the C (cold) and H (hot) marks. Wait for the temperature gauge needle to move above the C mark before riding. If the needle reaches the H mark, stop the engine and check the reserve tank coolant level (page 22).

Do not ride the motorcycle until the problem has been corrected.

### **CAUTION:**

- ***Exceeding maximum running temperature may cause serious engine damage.***

# PARTS LOCATION

---

(For model equipped with CBS/ABS/TCS)

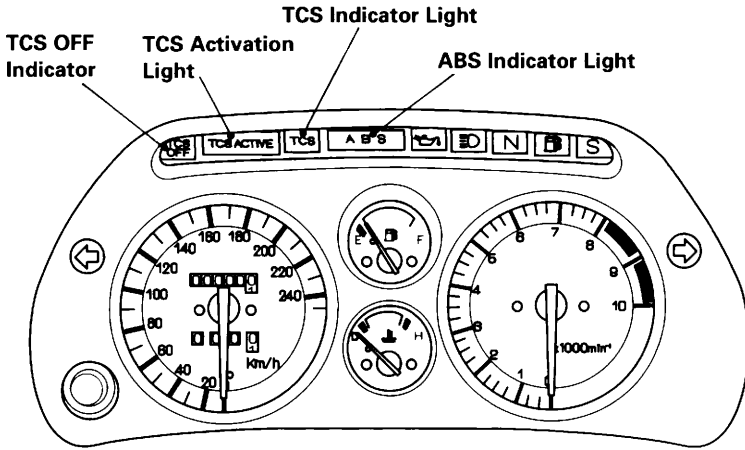

## Anti-lock Brake System (ABS) Indicator Light:

This light normally comes on when the ignition is turned ON and goes off after starting to ride.

If there is a problem with the Anti-lock Brake System, this light comes on and remains on — or blinks. (See chart on page 15.) For information about ABS, see page 54.

## Traction Control System (TCS) Indicator Light:

This light normally comes on when the ignition is turned ON and goes off after starting to ride.

If there is a problem with the Traction Control System, this light comes on and remains on — or blinks. (See chart on page 15.) For more information about TCS, see page 58.









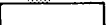

## TCS Activation Light:

This light lights when the traction control system is activated to regulate the engine (see page 58). It will normally light for a few seconds when you turn the ignition switch ON.

## TCS OFF Indicator:

This indicator lights when the traction control system is OFF (see pages 59 and 60). It will normally light for a few seconds when you turn the ignition switch ON.

## ABS and TCS Indicator Light Operation

	Ignition "ON"	After Starting to Ride	Normal: OK Not working: NG
ABS Indicator Light	  Comes ON   Blinks	 Goes OFF  Remains ON  Blinks	OK NG NG NG
TCS Indicator Light	  Comes ON   Blinks	 Goes OFF  Remains ON  Blinks	OK NG NG NG

If either the ABS or TCS Indicator Light does not operate properly,  
See your authorized Honda dealer for service.

# MAJOR COMPONENTS

(Information you need to operate this motorcycle)

---

## **▲ WARNING**

- *If the Pre-ride Inspection (page 47) is not performed, severe personal injury or vehicle damage may result.*

## REAR SUSPENSION

### Spring preload adjustment:

The rear shock absorber has five adjustment positions for different load or riding conditions.

Remove the right saddlebag (page 42) and right side cover (page 71).

Use the pin spanner in the tool kit to adjust the rear shock.

Position 1 is for a light load and smooth road conditions.

Position 2 is the standard position.

Positions 3 to 5 increase spring preload for a stiffer rear suspension, and can be used when the motorcycle is more heavily loaded.

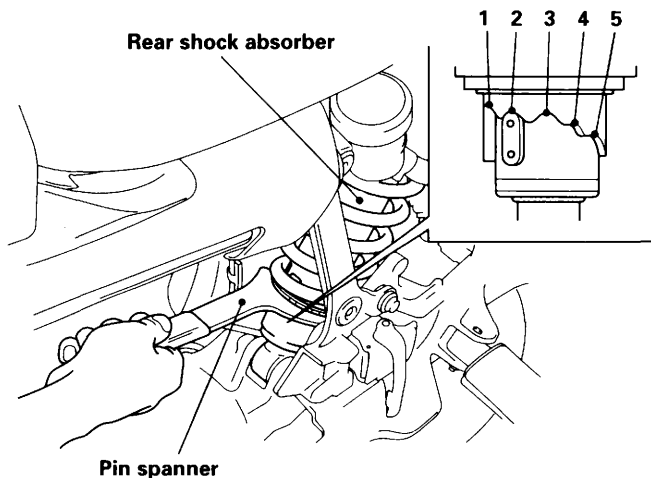

**Rebound Damping adjustment:**

The rebound damping adjuster has four adjustment positions. To adjust to the standard position, proceed as follows:

1. Turn the adjuster clockwise until it stops.
2. Turn the adjuster counterclockwise 1 turn (model equipped with CBS/ABS/TCS: 1/2 turn) to align the punch mark on the adjuster with the reference mark.

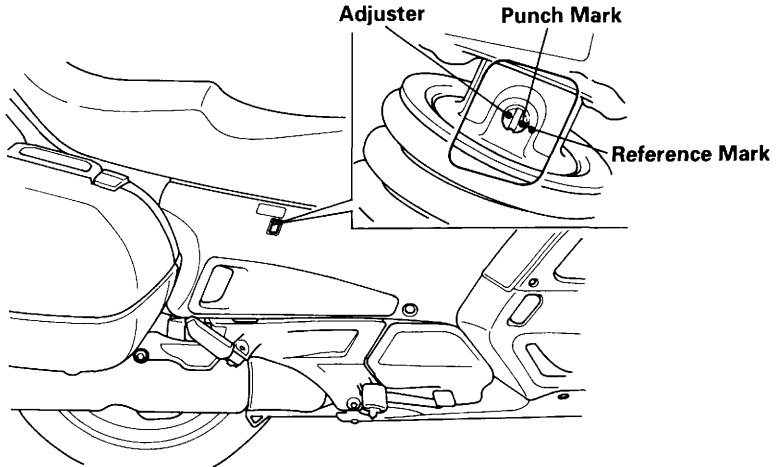

**Recommended adjuster positions:**

CONDITIONS		REBOUND DAMPING	SPRING PRELOAD
Rider	Cargo	Turn clockwise from standard position	
One	—	0° (no adjustment)	1 or 2
One	Cargo	180° (1/2 turn)	3
Two	—	270° (3/4 turn)	4
Two	Cargo	270° or 360° (3/4 to 1 full turn)	5

(For model equipped with CBS/ABS/TCS)

CONDITIONS		REBOUND DAMPING	SPRING PRELOAD
Rider	Cargo	Turn clockwise from standard position	
One	—	0° (no adjustment)	1 or 2
One	Cargo	0° (no adjustment)	3
Two	—	90° (1/4 turn)	4
Two	Cargo	90° or 180° (1/4 to 1/2 full turn)	5

# MAJOR COMPONENTS

## (Information you need to operate this motorcycle)

---

### BRAKES

Both front and rear brakes are hydraulic disc types.

As the brake pads wear, the brake fluid level will drop. Therefore, the brake fluid level and pad wear must be inspected periodically. The system must be inspected frequently to ensure there are no fluid leaks. If the control lever or pedal free travel becomes excessive and the brake pads are not worn beyond the recommended limit (page 93), there is probably air in the brake system and it must be bled. See your authorized Honda dealer for this service.

#### Brake Fluid Level:

#### **▲ WARNING**

- ***Brake fluid may cause irritation. Avoid contact with skin or eyes. In case of contact, flush thoroughly with water and call a doctor if your eyes were exposed.***
- ***KEEP OUT OF REACH OF CHILDREN.***

#### **CAUTION:**

- ***When adding brake fluid, be sure the reservoir is horizontal before the cap is removed or brake fluid may spill out.***
- ***Use only DOT 4 brake fluid from a sealed container.***
- ***Never allow contaminants such as dirt or water to enter the brake fluid reservoir.***
- ***Handle brake fluid with care because it can damage plastic and painted surfaces.***

Check that the fluid level is above the LOWER level mark with the motorcycle in an upright position.

Brake fluid must be added to the reservoir whenever the fluid level begins to reach the LOWER level mark.

---

## Front Brake

The front brake motor cylinder is located on the right handlebar. Fill the reservoir with DOT 4 BRAKE FLUID from a sealed container up to the upper level mark.

Reinstall the removed parts in the reverse order of removal. Tighten the screws securely.

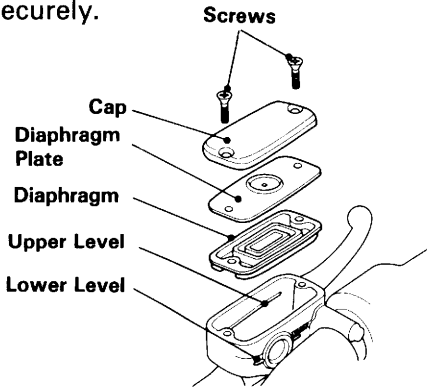

## Rear Brake

1. Remove the right saddlebag (page 42) and right side cover (page 71).
2. Remove the cap.
3. Fill the reservoir with DOT 4 BRAKE FLUID from a sealed container up to the upper level mark.
4. Reinstall the removed the cap.

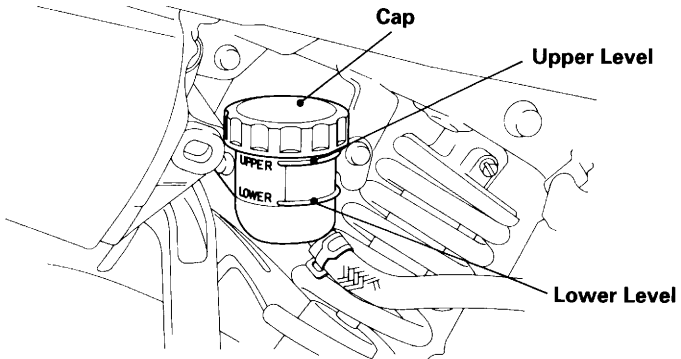

## Other Checks:

Make sure there are no fluid leaks. Check for deterioration or cracks in the hoses and fittings.

## MAJOR COMPONENTS

### (Information you need to operate this motorcycle)

---

#### Front Brake Lever:

The distance between the tip of the brake lever and the grip can be adjusted by turning the adjuster.

#### **CAUTION:**

- ***Align the arrow on the brake lever with the index mark on the adjuster.***

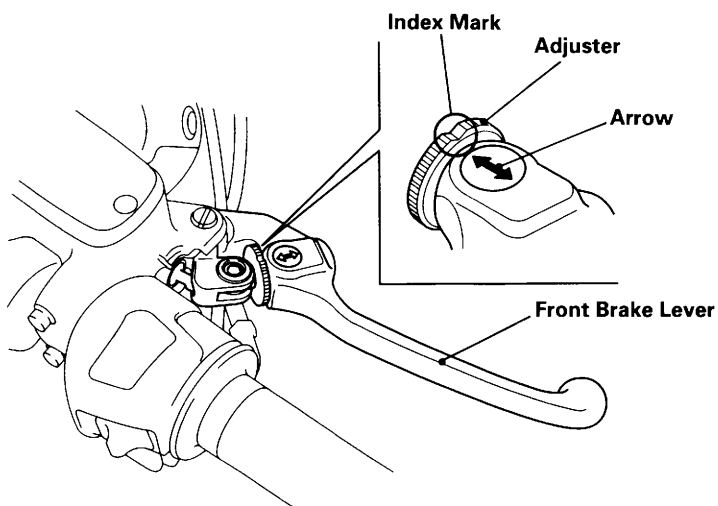

---

## CLUTCH

This motorcycle has a hydraulically actuated clutch. There are no adjustments to perform but the clutch system must be inspected periodically for fluid level and leakage. If the control lever freeplay becomes excessive and the motorcycle creeps or stalls when shifted into gear, or if the clutch slips, causing acceleration to lag behind engine speed, there is probably air in the clutch system and it must be bled out. See your authorized Honda dealer for this service.

### Fluid level:

Check that the fluid level is above the LOWER level mark. If the fluid level is near the LOWER level mark, it indicates fluid leakage. See your authorized Honda dealer for repair.

### Other Checks:

Make sure there are no fluid leaks. Check for deterioration or cracks in the hose and fittings.

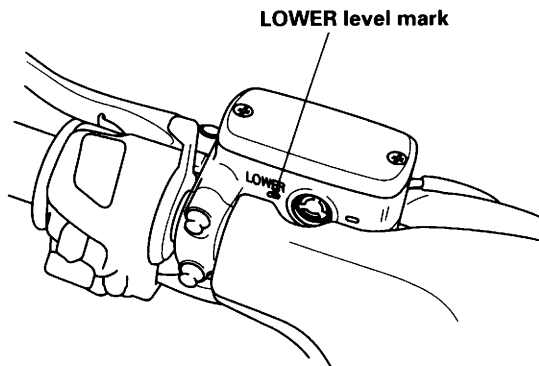

## MAJOR COMPONENTS

### (Information you need to operate this motorcycle)

---

#### COOLANT

##### Coolant Recommendation

The owner must properly maintain the coolant to prevent freezing, overheating, and corrosion. Use only high quality ethylene glycol antifreeze containing corrosion protection inhibitors specifically recommended for use in aluminum engines. (SEE ANTIFREEZE CONTAINER LABEL).

##### CAUTION:

- ***Use only low-mineral drinking water or distilled water as a part of the antifreeze solution. Water that is high in mineral content or salt may be harmful to the aluminum engine.***

The factory provides a 50/50 solution of antifreeze and water in this motorcycle. This coolant solution is recommended for most operating temperatures and provides good corrosion protection. A higher concentration of antifreeze decreases cooling system performance and is recommended only when additional protection against freezing is needed. A concentration of less than 40/60 (40% antifreeze) will not provide proper corrosion protection. During freezing temperatures, check the cooling system frequently and add higher concentrations of antifreeze (up to a maximum of 60% antifreeze) if required.

##### Inspection

The coolant reserve tank is behind the right side cover (right side cowl for model equipped with CBS/ABS/TCS). Check the coolant level in the reserve tank while the engine is at normal operating temperature. If the coolant is low, remove the right side cover (page 71) or air duct/maintenance cover (page 71) and add coolant to the reserve tank as required to bring the coolant level to the UPPER level mark.

If the reserve tank is empty, or if coolant loss is excessive, check for leaks and see your authorized Honda dealer for repair.

##### WARNING

- ***Do not remove the radiator cap when the engine is hot. The coolant is under pressure and could scald you.***
- ***Keep hands and clothing away from the cooling fan, as it starts automatically.***

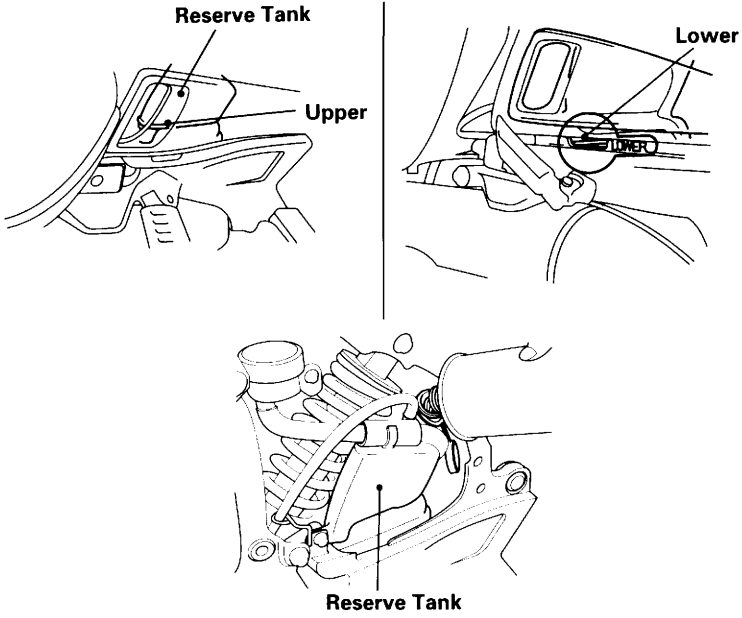

(Model equipped with CBS/ABS/TCS)

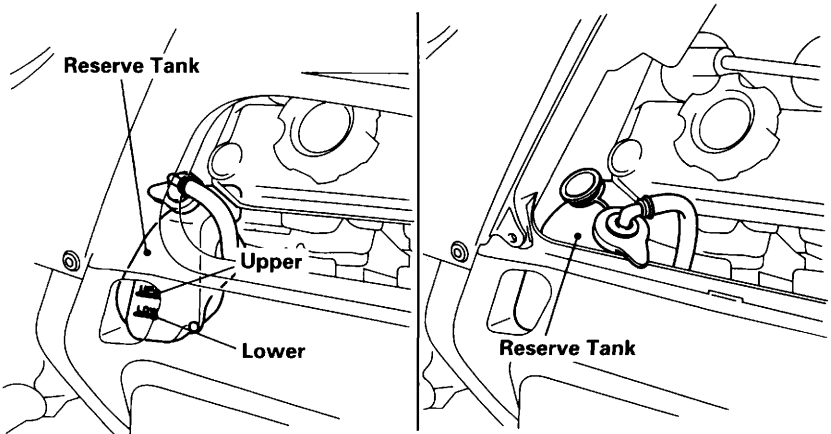

# MAJOR COMPONENTS

## (Information you need to operate this motorcycle)

---

### FUEL

#### Automatic Fuel ON-OFF

Fuel will flow to the carburetors only when the engine is started or is running.

#### Fuel Tank

Fuel tank capacity is 28 ℓ (7.4 US gal, 6.1 Imp gal). Insert the ignition key and turn it clockwise to open the fuel filler compartment. Turn the fuel fill cap counterclockwise to remove it.

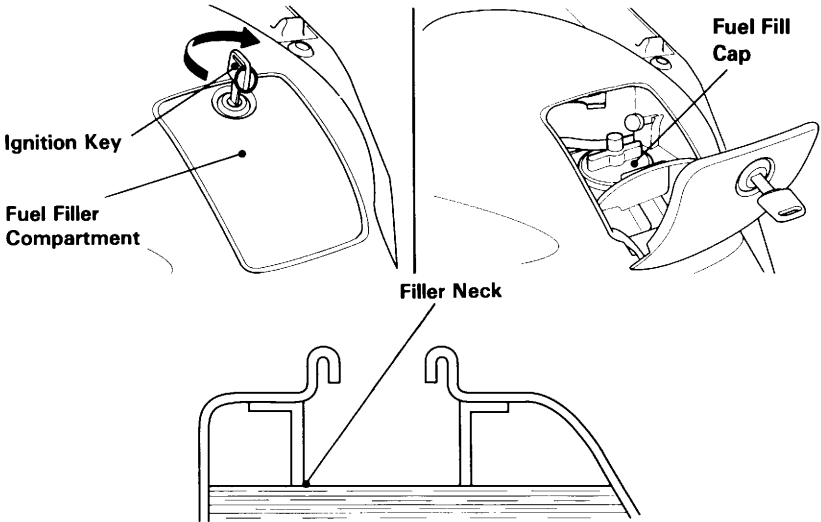

Use unleaded or low-lead petrol with a research octane number of 91 or higher. We recommend that you use unleaded petrol because it produces fewer engine and spark plug deposits and extends the life of exhaust system components.

#### FOR AUSTRALIA ONLY:

Use unleaded petrol with a research octane number of 91 or higher.

Never use stale or contaminated petrol or an oil/petrol mixture. Avoid getting dirt, dust or water in the fuel tank. Use of a lower octane petrol can cause persistent “pinging” or heavy “spark knock” (a metallic rapping noise) which, if severe, can lead to engine damage.

---

**CAUTION:**

- *If “spark knock” or “pinging” occurs at a steady engine speed under normal load, change brands of petrol. If spark knock or pinging persists, consult your authorized Honda dealer. Failure to do so is considered misuse, and damage caused by misuse is not covered by Honda’s Limited Warranty.*

Occasionally you may experience light spark knock while operating under heavy loads. This is no cause for concern, it simply means your engine is operating efficiently.

Install the fuel fill cap by turning it clockwise. Be sure to properly route the hose attached to the top of the cap.

Close the fuel filler compartment lid with the key inserted and turned clockwise, then turn the key counterclockwise to lock the lid.

**▲ WARNING**

- *Petrol is extremely flammable and is explosive under certain conditions. Refuel in a well-ventilated area with the engine stopped. Do not smoke or allow flames or sparks in the area where petrol is stored or where the fuel tank is refueled.*
- *Do not overfill the tank (there should be no fuel in the filler neck). After refueling, make sure the tank cap is closed properly and securely.*
- *Be careful not to spill fuel when refueling. Spilled fuel or fuel vapor may ignite. If any fuel is spilled, make sure the area is dry before starting the engine.*
- *Avoid repeated or prolonged contact with skin or breathing of vapor. KEEP OUT OF REACH OF CHILDREN.*

## **MAJOR COMPONENTS**

### **(Information you need to operate this motorcycle)**

---

#### **Petrol Containing Alcohol**

If you decide to use a petrol containing alcohol (gasohol), be sure its octane rating is at least as high as that recommended by Honda. There are two types of "gasohol": one containing ethanol, and the other containing methanol. Do not use gasohol that contains more than 10% ethanol. Do not use petrol containing methanol (methyl or wood alcohol) that does not also contain cosolvents and corrosion inhibitors for methanol. Never use petrol containing more than 5% methanol, even if it has cosolvents and corrosion inhibitors.

#### **NOTE:**

- Fuel system damage or engine performance problems resulting from the use of fuels that contain alcohol are not covered under the warranty. Honda cannot endorse the use of fuels containing methanol since evidence of their suitability is as yet incomplete.
- Before buying fuel from an unfamiliar station, try to find out if the fuel contains alcohol. If it does, confirm the type and percentage of alcohol used. If you notice any undesirable operating symptoms while using a petrol that contains alcohol, or one that you think contains alcohol, switch to a petrol that you know does not contain alcohol.

---

## ENGINE OIL

Check engine oil level each day before operating the motorcycle.

To check the oil level:

1. Place the motorcycle on its center stand on firm, level ground.
2. Start the engine and let it idle for a few minutes.
3. Stop the engine. After a few minutes, check the oil level inspection window.

The oil level should be between the upper and lower level marks.

4. If required, remove the air duct/maintenance cover (page 71) and oil filler cap, add the specified oil up to the upper level mark. Do not overfill.
5. Reinstall the oil filler cap and the air duct/maintenance cover (if removed).

### CAUTION:

- ***Running the engine with insufficient oil can cause serious engine damage.***

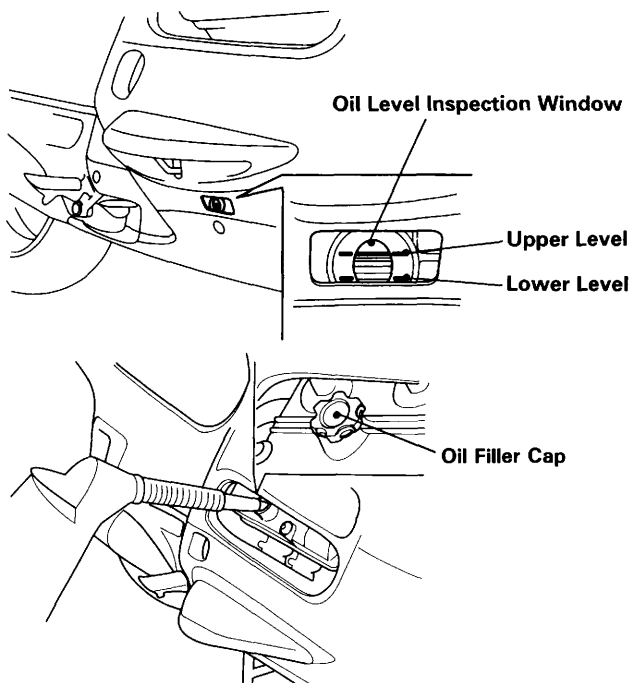

# MAJOR COMPONENTS

## (Information you need to operate this motorcycle)

### Engine Oil

Good engine oil has many desirable qualities. Use only high detergent, quality motor oil certified on the container to meet or exceed requirements for API Service Classification SE, SF or SG.

### Viscosity

Viscosity grade of engine oil should be based on average atmospheric temperature in your riding area. The following provides a guide to the selection of the proper grade or viscosity of oil to be used at various atmospheric temperatures.

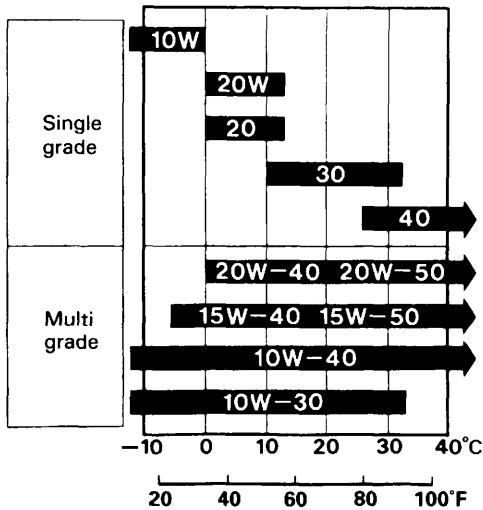

---

## FINAL DRIVE OIL

### Oil Level Check

Check the final drive oil level when specified by the maintenance schedule.

1. Place the motorcycle on its center stand on firm, level ground.
2. Remove the oil filler cap.
3. The oil level should be flush with the lower edge of the oil filler hole.

### NOTE:

- If the level is low, check for leaks. Add the recommended oil through the oil filler hole until it reaches the lower edge of the opening.

**Recommended Oil: HYPOID GEAR OIL SAE 80**

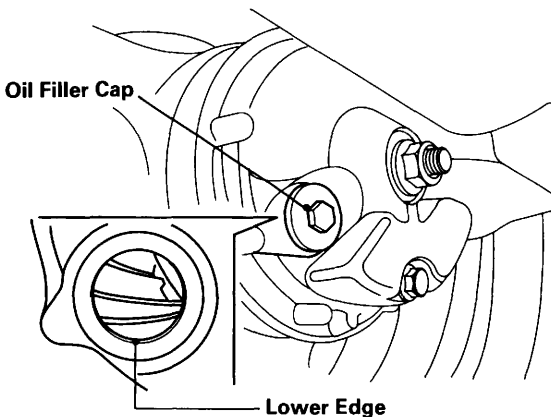

## MAJOR COMPONENTS

### (Information you need to operate this motorcycle)

---

#### TUBELESS TYRES

This motorcycle is equipped with tubeless tyres, valves, and wheel rims. Use only tyres marked "TUBELESS" and tubeless valves on rims marked "TUBELESS TYRE APPLICABLE."

Never mount tyres designed for use on automobiles on a motorcycle rim.

#### WARNING

- ***Any attempt to mount passenger car tyres on a motorcycle rim may cause the tyre bead to separate from the rim with enough explosive force to cause serious injury or death.***

Proper air pressure will provide maximum stability, riding comfort and tyre life. Check tyre pressure frequently and adjust if necessary.

#### NOTE:

- Tyre pressure should be checked before you ride while the tyres are "cold."
- Tubeless tyres have some degree of self-sealing ability if they are punctured, and leakage is often very slow. Inspect very closely for punctures, especially if the tyre is not fully inflated.

		Front	Rear
TYRE SIZE TYRE BRAND TUBELESS ONLY DUNLOP BRIDGESTONE		110/80 V18  D103F G547	160/70 V17  D103 G548
TYRE SIZE TYRE BRAND TUBELESS ONLY METZELER		110/80 V18—V240  ME33 LASER	160/70 VB17—V240  ME55A METRONIC
Cold tyre pressures psi (kPa, kgf/cm <sup>2</sup> )	Up to 90 kg (200 lbs) load	36 (250, 2.50)	42 (290, 2.90)
	90 kg (200 lbs) load to vehicle capacity load	36 (250, 2.50)	42 (290, 2.90)

(Model equipped with CBS/ABS/TCS)

		Front	Rear
TYRE SIZE TYRE BRAND TUBELESS ONLY DUNLOP BRIDGESTONE		120/70 ZR18  D202F BT-54F	160/70 ZR17  D202 BT-54R
Cold tyre pressures psi (kPa, kgf/cm <sup>2</sup> )	Up to 90 kg (200 lbs) load	36 (250, 2.50)	42 (290, 2.90)
	90 kg (200 lbs) load to vehicle capacity load	36 (250, 2.50)	42 (290, 2.90)

## MAJOR COMPONENTS

### (Information you need to operate this motorcycle)

Check the tyres for cuts, embedded nails or other sharp objects. Check the rims for dents or deformation. If there is any damage, see your authorized Honda dealer for repair, replacement, and balancing.

#### ⚠ WARNING

- ***Improper tyre inflation will cause abnormal tread wear and create a safety hazard. Underinflation may result in the tyre slipping on, or coming off of the rim causing tyre deflation that may result in a loss of vehicle control.***
- ***Operation with excessively worn tyres is hazardous and will adversely affect traction and handling.***

Replace tyres before tread depth at the center of the tyre reaches the following limit or when the surface is flush with the wear indicators.

Minimum tread depth	
Front:	1.5 mm (0.06 in)
Rear:	2.0 mm (0.08 in)

NOTE: <For Germany>

- German law prohibits use of tyres whose tread depth is less than 1.6 mm.

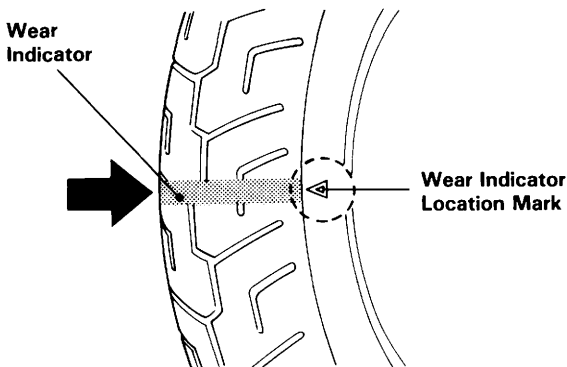

---

## Tyre Repair/Replacement

See your authorized Honda Dealer.

### **▲ WARNING**

- *The use of tyres other than those listed on the tyre information label may adversely affect handling.*
- *Do not install tube-type tyres on tubeless rims. The beads may not seat and the tyres could slip on the rims, causing tyre deflation that may result in a loss of vehicle control.*
- *Any attempt to mount passenger car tyres on a motorcycle rim may cause the tyre bead to separate from the rim with enough explosive force to cause serious injury or death.*
- *Do not install a tube inside a tubeless tyre. Excessive heat build-up may cause the tube to burst resulting in rapid tyre deflation that may result in a loss of vehicle control.*
- *Proper wheel balance is necessary for safe, stable handling of the motorcycle. Do not remove or change any wheel balance weights. When wheel balancing is required, see your authorized Honda dealer. Wheel balancing is required after tyre repair or replacement.*
- *To avoid possible repair failure and tyre deflation that may result in a loss of vehicle control, do not exceed 80 km (50 mph) for the first 24 hours, or 130 km (80 mph) at any time, after tyre repair.*
- *Replace the tyre if the sidewall is punctured or damaged. Sidewall flexing may cause repair failure and tyre deflation that may result in a loss of vehicle control.*

### **CAUTION:**

- *Do not try to remove tubeless tyres without special tools and rim protectors. You may damage the rim sealing surface or disfigure the rim.*
- *When replacing tyres, use the same tyres those listed on the tyre information label. Use of other tyres on the model equipped with CBS/ABS/TCS may impair proper ABS and TCS function.*

# ESSENTIAL INDIVIDUAL COMPONENTS

## IGNITION SWITCH

The ignition switch is on the handlebar cover.

Key Position	Function Key	Key Removal
ON	All electrical circuits are on. Engine and lights can be operated.	Key cannot be removed.
OFF	All electrical circuits are off. (Except for Digital clock) Engine cannot be started.	Key can be removed.
LOCK (steering lock)	Steering is locked. Engine and lights cannot be operated.	Key can be removed.

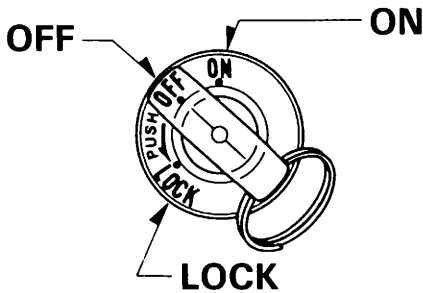

---

## RIGHT HANDLEBAR CONTROLS

### Engine Stop Switch

The two position engine stop switch is next to the throttle grip. When the switch is in the ○ (RUN) position, the engine will operate. When the switch is in the ⊗ (OFF) position, the engine will not operate. This switch is intended primarily as a safety or emergency switch and should normally remain in the ○ (RUN) position.

#### NOTE:

- If your motorcycle is stopped with the ignition switch ON and the engine stop switch OFF, the headlight and taillight will still be on, resulting in battery discharge.

### Starter Button

The starter button is below the engine stop switch. When the starter button is pressed, the starter motor will crank the engine. If the engine stop switch is in the ⊗ (OFF) position, the starter motor will not operate.

See pages 49—50 for "Starting Procedure."

### Headlight Switch (Except U type)

The headlight switch has three positions, ☀, ☁ and "OFF" marked by dot.

☀: Headlight, taillight, position light and meter lights on.

☁: Position light, taillight and meter lights on.

OFF (dot): Headlight, taillight, position light and meter lights off.

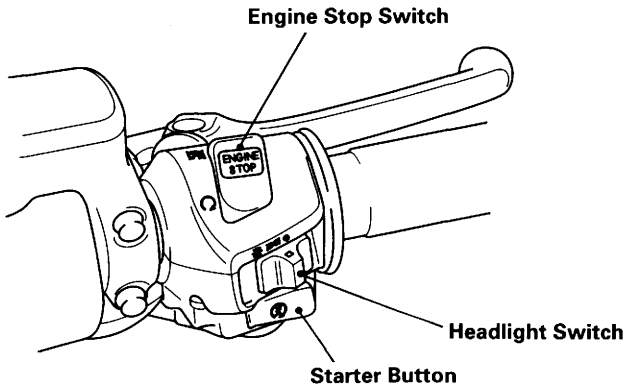

# ESSENTIAL INDIVIDUAL COMPONENTS

---

## LEFT HANDLEBAR CONTROLS

The controls next to the left handlebar grip are:



### Headlight Dimmer Switch

Select  (HI) for high beam,  (LO) for low beam.

### Horn Button

Press the button to sound the horn.

### Turn Signal Switch

Move the switch to  (L) to signal a left turn, to  (R) to signal a right turn; the appropriate turn signal and indicator will blink. Push to turn signal off.

### Passing Light Control Switch

When this switch is pressed, the headlight flashes on to signal approaching cars or when passing.

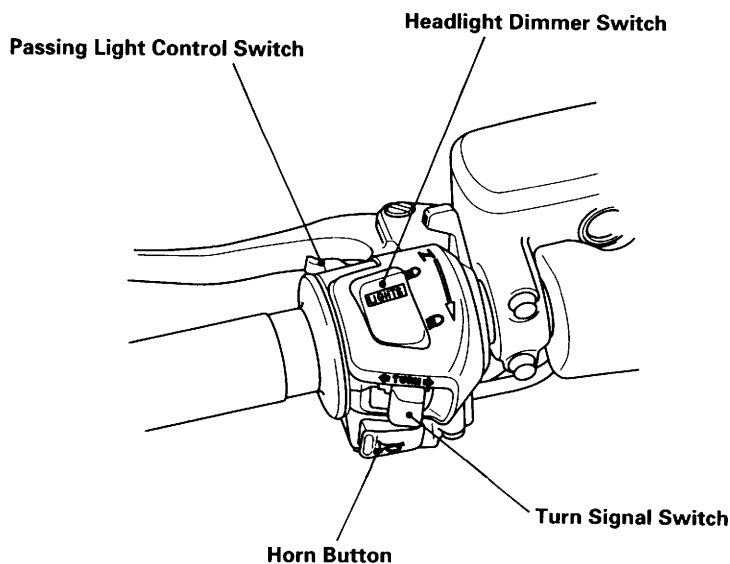

# **FEATURES (Not required for operation)**

---

## **STEERING LOCK**

To lock the steering, turn the handlebars all the way to the left or right, turn the key to LOCK while pushing in. Remove the key.

### **⚠ WARNING**

- ***Do not turn the key to LOCK while riding the motorcycle; loss of vehicle control may result.***

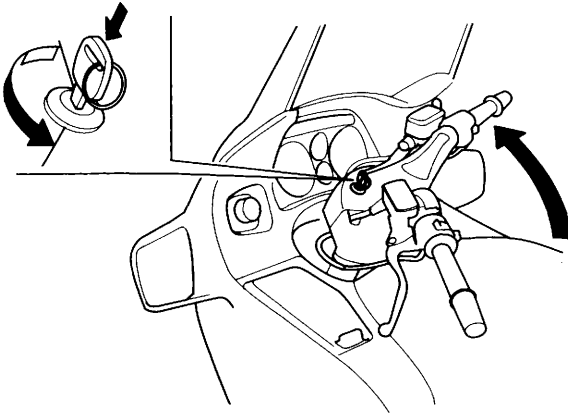

## **SEAT**

To remove the seat, insert the ignition key into the lock and turn it clockwise.

### **CAUTION:**

- ***Be sure to securely lock the seat after installing it.***

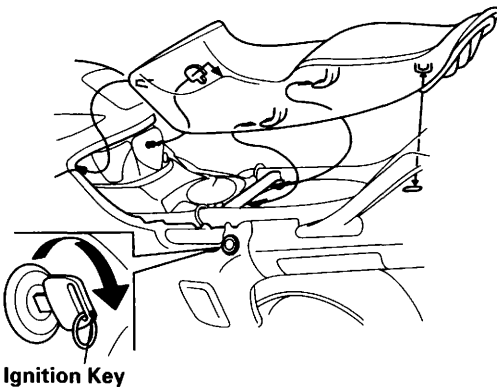

**Ignition Key**

## FEATURES (Not required for operation)

---

### HELMET HOLDERS

The helmet holders are under the seat.

Remove the seat (page 37). Hang your helmet(s) on the holder pin. Install the seat.

#### **⚠ WARNING**

- ***The helmet holder is designed for helmet security while parked. Do not ride with a helmet attached to the holder; the helmet may interfere with safe operation and result in loss of control.***

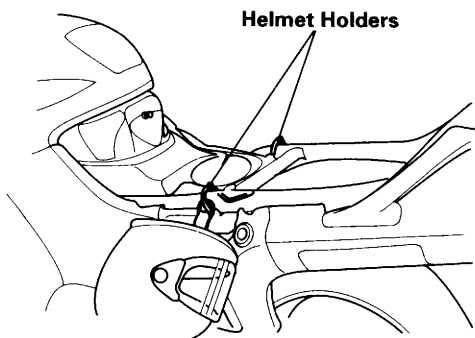

### LUGGAGE TIE-DOWN HOOKS

Two Luggage tie-down hooks are located under the seat.

Remove the seat (page 37). Open the tie-down hooks and install the seat.

#### **CAUTION:**

- ***Never use the tie-down hooks to tow or lift the motorcycle.***

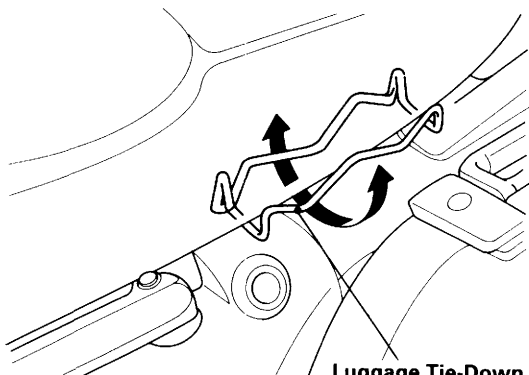

Luggage Tie-Down Hooks

---

## DOCUMENT COMPARTMENT

The document compartment is behind the seat.

The owners manual and other documents should be stored in the plastic bag.

### NOTE:

- When washing your motorcycle, be careful not to flood this area with water.

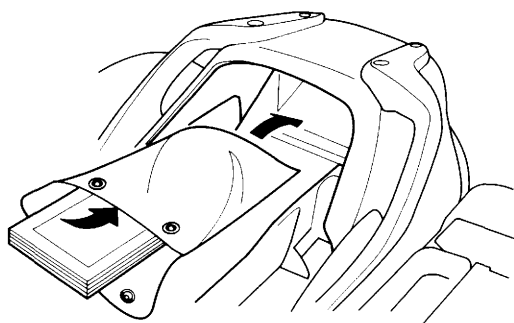

# **FEATURES (Not required for operation)**

---

## **DIGITAL CLOCK**

Shows hour and minute. To adjust time, proceed as follows:

1. Turn the main switch ON.
2. Press the "RST" button (Reset button). The minute display will read "00".
3. Press the "H" button (Hour button). Hold the button down until the desired hour is displayed.
4. Press the "M" button (Minute button). Hold the button down until the desired minute is displayed. The minute display will return to "00" when "60" is reached without affecting the hour display.

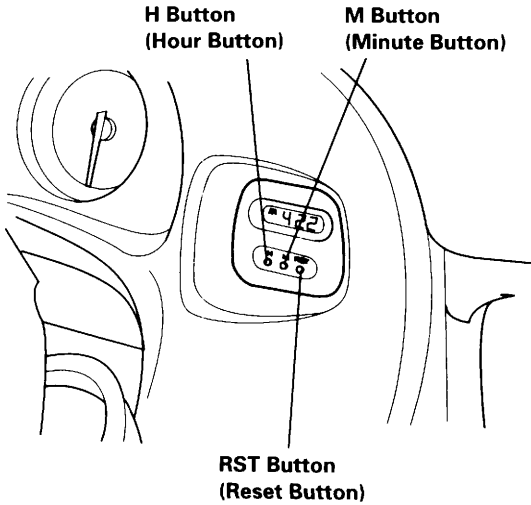

---

## SADDLEBAGS

To open the saddlebags:

Insert the ignition key and turn it counterclockwise to open the saddlebag.

To lock the saddlebags:

Close the saddlebags and turn the ignition key clockwise. Make sure the saddlebags are locked.

### **▲ WARNING**

- ***The saddlebag is for lightweight items. Do not carry more than 9 kg (20 lbs) in each side. Excessive weight may adversely affect vehicle handling and control.***
- ***Load weight equally in both sides to minimize an imbalance that may result in a loss of vehicle control.***
- ***Review Loading and Accessories (page 4) before loading.***

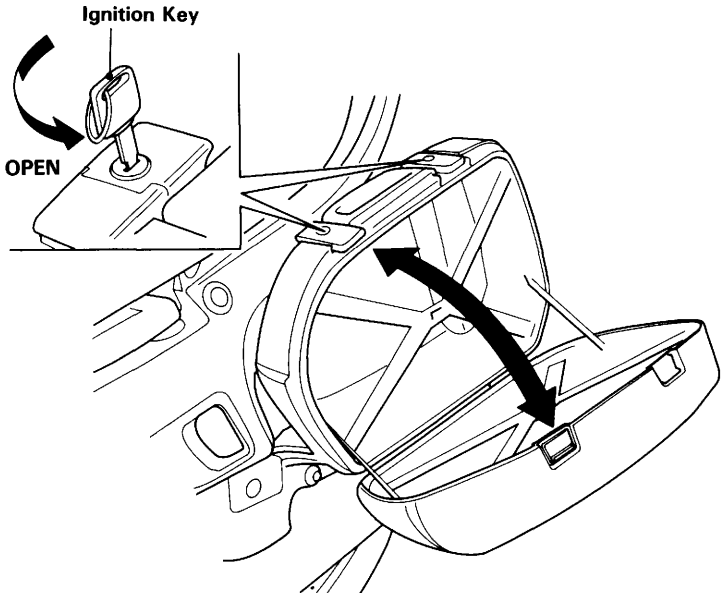

## **FEATURES (Not required for operation)**

---

### To remove the saddlebags:

Insert the ignition key and turn it counterclockwise to open the latch lever. Remove the saddlebag by sliding it backward ①, lifting up ② and pulling it out toward you ③ as shown.

### NOTE:

- After removing, lock the latch lever with ignition key.
- Do not remove the protective tapes from the rear cowl and saddlebags when removing the saddlebags.

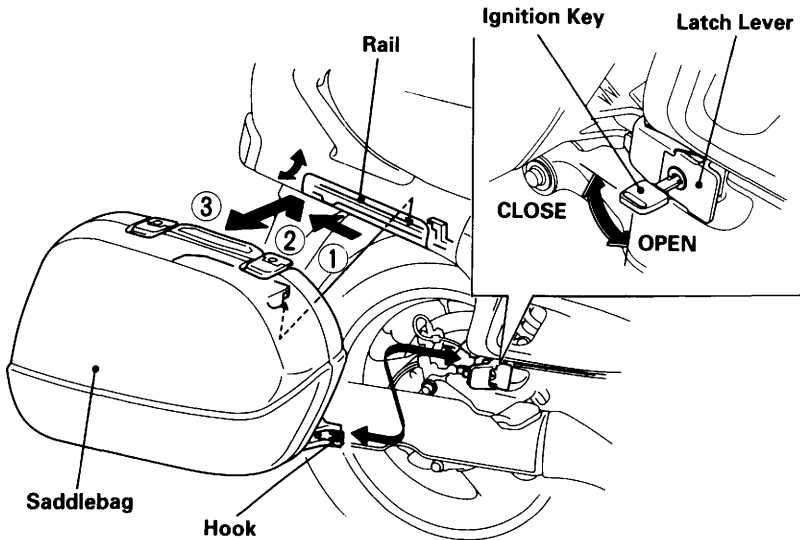

### To install the saddlebags:

- Reverse the removal procedure.
- Make sure the hooks are aligned before pushing the saddlebag forward.
- After installing the saddlebags, check that the hooks engage securely.
- Close the latch lever and turn the ignition key clockwise.

### NOTE:

- Make sure the latch levers are locked before riding.

---

## FAIRING POCKETS

Fairing pockets are located on both sides of the motorcycle.

To open the left pocket lid, pull up the knob.

To remove the right pocket lid, insert the ignition key, turn it clockwise and open the lid.

### NOTE:

- Make sure the fairing pockets are closed before riding.
- When washing your motorcycle, be careful not to flood this area with water.

### ⚠ WARNING

- ***Fairing pockets are for lightweight items. Do not carry more than 2 kg (4.5 lbs) in each side.***
- ***Load weight equally in both sides to avoid and imbalance that may result in a loss of vehicle control.***
- ***Excessive weight may adversely affect vehicle handling and control.***
- ***Review Loading and Accessories before loading (page 4).***

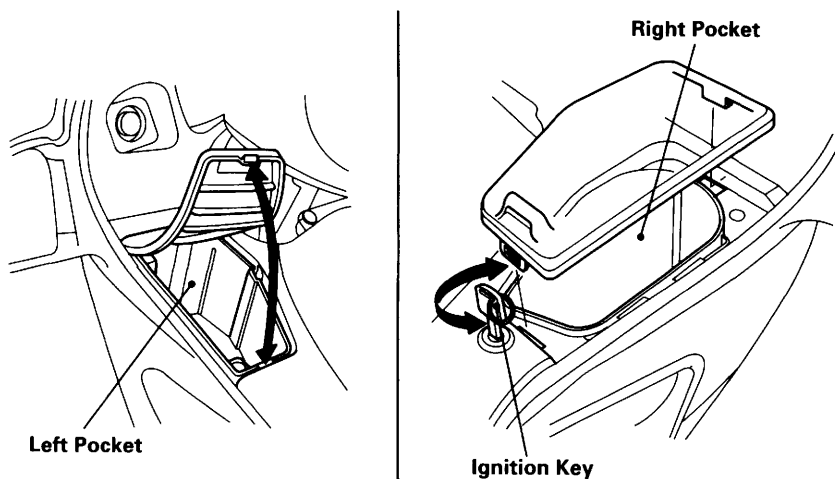

## **FEATURES (Not required for operation)**

---

### **REAR VIEW MIRRORS**

Both rear view mirror assemblies use a special breakaway mount which allows a controlled separation of the mirror assembly from its base upon impact with an obstacle. A short cable keeps the mirror assembly connected to the mirror bracket.

#### Installation:

- Check the mirror for correct angle.
- Press on the mirror cover firmly until it clicks into position on the mirror mount.
- After reinstalling, check the mirror for correct angle and the front turn signals for proper operation.

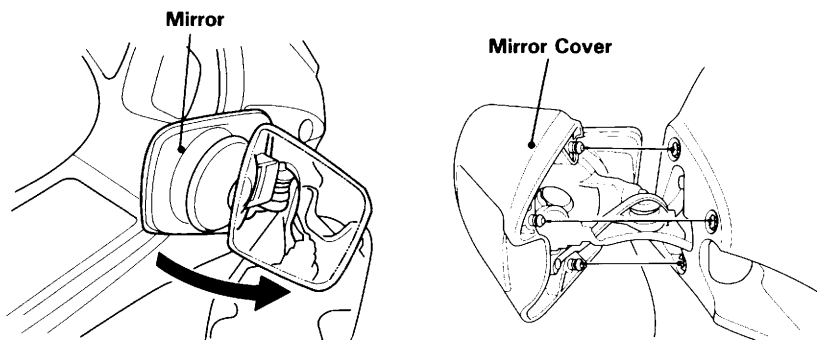

#### **CAUTION:**

- ***Riding with a mirror assembly hanging by its retaining cable may damage the motorcycle's plastic body.***

#### **NOTE:**

- For your safety, be sure to immediately reinstall any separated mirror assembly. Otherwise, the mirror and turnsignal will not be available to you while riding.

If a mirror assembly is damaged so badly that it cannot be reused or reinstalled on its base, remove it from the base and transport the motorcycle to an authorized Honda dealer.

---

## HEADLIGHT BEAM ADJUSTMENT

The headlight beam can be raised or lowered by turning the vertical beam adjusting knob. Obey local laws and regulations concerning headlight adjustment.

**⚠ WARNING**

- ***Do not adjust the headlight beam while riding the motorcycle. Operating the motorcycle with one or both hands away from the handlebar/controls may result in a loss of vehicle control.***

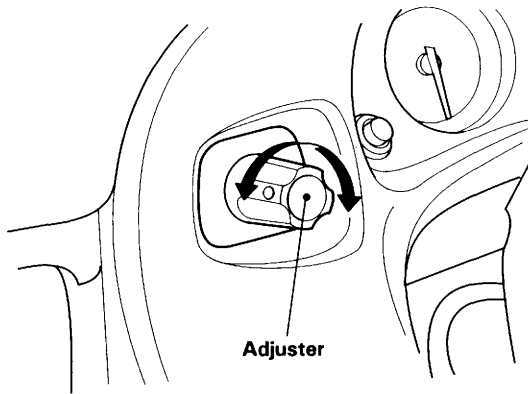

## **FEATURES (Not required for operation)**

---

### **ACCESSORY (ACC) TERMINAL**

The accessory terminal (ACC terminal) is located behind the fuse box and provides 12V DC power for electrical accessories. A maximum of 60 watts (5 amps) may be connected to the terminal. If equipped with accessories, check the battery frequently to determine the state of charge and examine it for possible sulfation. Higher current damages may blow the fuse or discharge the battery. Review the **LOADING AND ACCESSORY WARNING** (page 4) before installing accessories. Connect accessory electrical leads securely, and keep them insulated, away from hot parts and sharp edges.

### **CAUTION:**

- ***Do not exceed 5 amps for prolonged current demands.***

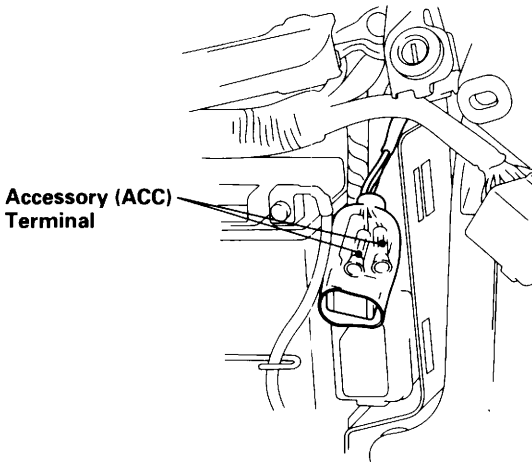
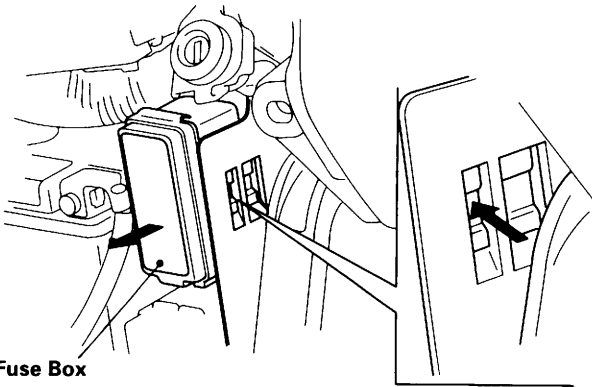

# OPERATION

---

## PRE-RIDE INSPECTION

### WARNING

- ***If the Pre-ride Inspection is not performed, severe personal injury or vehicle damage may result.***

Inspect your motorcycle every day before you ride. The items listed here will only take a few minutes to inspect, and in the long run they can save time, expense, and possibly your life.

1. Engine oil level—add engine oil if required (page 27). Check for leaks.
2. Fuel level—fill fuel tank when necessary (page 24). Check for leaks.
3. Coolant level—add coolant if required. Check for leaks (pages 22—23).
4. Front and rear brakes—check operation; make sure there is no brake fluid leakage. (pages 18—20, 90)
5. Tyres—check condition (pages 30—32) and pressure (page 31).
6. Throttle—check for smooth opening and full closing in all steering positions.
7. Lights and horn—check that headlight, tail/brake light, turn signals, indicators and horn function properly.
8. Engine stop switch—check for proper function (page 35).
9. Side stand ignition cut-off system—check for proper function (page 95).

Correct any discrepancy before you ride. Contact your authorized Honda dealer for assistance if you cannot correct the problem.

# OPERATION

---

## STARTING THE ENGINE

Always follow the proper starting procedure described below.

This motorcycle is equipped with a side stand ignition cut-off system. The engine cannot be started if the side stand is down, unless the transmission is in neutral. If the side stand is up, the engine can be started in neutral or in gear with the clutch lever pulled in. After starting with the side stand down, the engine will stop if the transmission is put in gear before raising the side stand.

### **▲ WARNING**

- ***Never run the engine in an enclosed area. The exhaust contains poisonous carbon monoxide gas that can cause loss of consciousness and lead to death.***
- ***Do not flood the engine by twisting the throttle repeatedly. The carburetor has an accelerator pump.***

### NOTE:

- Do not use the electric starter for more than 5 seconds at a time. Release the starter button for approximately 10 seconds before pressing it again.

### Preparation

Before starting, insert the key, turn the ignition switch ON and confirm the following:

- The transmission is in NEUTRAL (neutral indicator light ON).
- The engine stop switch is at ○ (RUN).
- The ABS Indicator Light, TCS Indicator Light, TCS OFF Indicator and TCS Activation Light are ON (For model equipped with CBS/ABS/TCS. See pages 14—15).
- The red low oil pressure indicator light is ON.

### CAUTION:

- ***The red low oil pressure indicator light should go off a few seconds after the engine starts. If the light stays on, stop the engine immediately and check engine oil level. Operating the engine with insufficient oil pressure can cause serious engine damage.***

---

## Starting Procedure

To restart a warm engine, follow the procedure for "High Air Temperature".

Normal Air Temperature 10° — 35°C (50° — 95°F):

1. Pull the choke lever back all the way to Fully On (B), if the engine is cold.
2. Start the engine, leaving the throttle closed.

### NOTE:

- Do not open the throttle when starting the engine with the choke on. This will lean the mixture, resulting in hard starting.

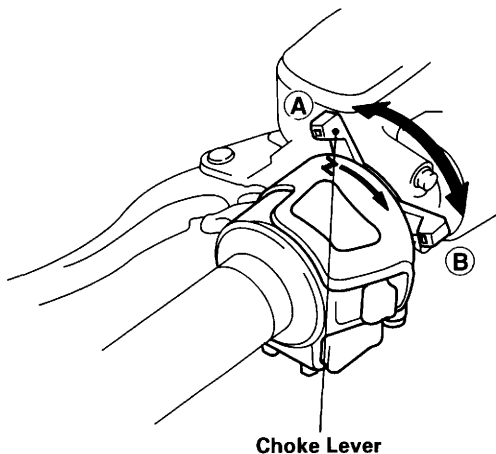

3. Immediately after the engine starts, operate the choke lever to keep fast idle at 2,000 — 2,500 min<sup>-1</sup> (rpm).
4. About a half minute after the engine starts, push the choke lever forward all the way to Fully Off (A).
5. If idling is unstable, open the throttle slightly.

# OPERATION

---

High Air Temperature 35°C (95°F) or above:

1. Do not use the choke.
2. Open the throttle slightly.
3. Start the engine.

Low Air Temperature 10°C (50°F) or below:

1. Follow steps 1 — 2 under “Normal Air Temperature”.
2. When engine speed begins to pick up, operate the choke lever to keep fast idle at 2,000 — 2,500 min<sup>-1</sup> (rpm).
3. Continue warming up the engine until it runs smoothly and responds to the throttle when the choke lever is at fully OFF (A).

## CAUTION:

- ***Snapping the throttle or fast idling for more than about 5 minutes at normal air temperature may cause exhaust pipe discoloration.***
- ***Extended use of the choke may impair piston and cylinder wall lubrication.***

---

## Flooded Engine

If the engine fails to start after repeated attempts, it may be flooded with excess fuel. To clear a flooded engine, leave the engine stop switch on  $\odot$  (RUN) and push the choke lever forward to Fully OFF (A). Open the throttle fully and crank the engine for 5 seconds. If the engine starts, quickly close the throttle, then open it slightly if idling is unstable. If the engine does not start, wait 10 seconds, then follow the "High Air Temperature" Starting Procedure. (page 49)

## RUNNING-IN

During initial running-in, newly machined surfaces will be in contact with each other and these surfaces will wear in quickly. Running-in maintenance at 1,000 km (600 miles) is designed to compensate for this initial minor wear. Timely performance of running-in maintenance will ensure optimum service life and performance from the engine.

The general rules are as follows:

1. Never lug the engine with full throttle at low engine speeds. This rule is applicable not only during running-in but at all times.
2. Maximum continuous engine speed during the first 1,000 km (600 miles) must not exceed 4,000  $\text{min}^{-1}$  (rpm).
3. Increase the maximum continuous engine speed by 1,000  $\text{min}^{-1}$  (rpm) between odometer readings of 1,000 km (600 miles) and 1,600 km (1,000 miles). Drive briskly, vary speeds frequently and use full throttle for short bursts only. Do not exceed 6,000  $\text{min}^{-1}$  (rpm).
4. Upon reaching an odometer reading of 1,600 km (1,000 miles), you can subject the motorcycle to full throttle operation. However, do not exceed 8,000  $\text{min}^{-1}$  (rpm)  
— indicated by the beginning of the tachometer redzone. (Do not let the tachometer needle enter the red zone.)

## CAUTION:

- ***Running the engine beyond recommended maximum engine speed (the beginning of the tachometer red zone) can damage the engine.***

# OPERATION

---

## RIDING

Review Motorcycle Safety (pages 1—6) before you ride.

### NOTE:

- Make sure the function of the side stand mechanism (See MAINTENANCE SCHEDULE on page 66 and explanation for SIDE STAND on page 95.)

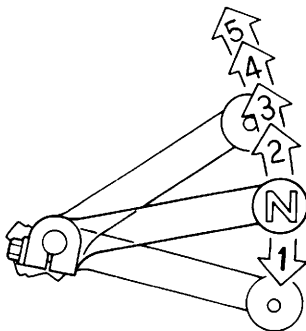

Proper shifting will provide better fuel economy.

### ▲ WARNING

- ***Do not downshift when traveling at a speed that would force the engine to overrev in the next lower gear; the rear wheel may lose traction, resulting in a possible loss of vehicle control.***

### CAUTION:

- ***Do not shift gears without disengaging the clutch and closing the throttle. The engine and drive train could be damaged by overspeed and shock.***
- ***Do not tow the motorcycle or coast for long distances while the engine is off. The transmission will not be properly lubricated and damage may result.***
- ***Do not run the engine at high rpm with the transmission in neutral or the clutch lever pulled in. Serious engine damage may result.***

### NOTE:

- Be careful when revving the engine or accelerating in 1st or 2nd gear as the engine speed will easily exceed redline.

---

## **BRAKING**

This motorcycle is equipped with hydraulically-actuated disc brakes.

### **Operation** — Both Models:

For normal braking, apply both the brake pedal and lever while downshifting to match your road speed. For maximum braking, close the throttle and firmly apply the pedal and the lever; pull in the clutch lever before coming to a complete stop to prevent stalling the engine.

### **Important Safety Reminders:**

- *Independent use of only the front or rear brake reduces stopping performance.*
- *When possible, reduce speed or brake before entering a turn; abruptly closing the throttle or braking hard in mid-turn may cause loss of traction which will reduce control of the motorcycle.*
- *When riding in wet or rainy conditions, or on loose surfaces, the ability to maneuver and stop will be reduced. All of your actions should be smooth under these conditions. Rapid acceleration, braking or turning may cause loss of control. For your safety, exercise extreme caution when braking, accelerating or turning.*
- *When descending a long, steep grade, use engine compression braking by downshifting, with intermittent use of both brakes. Continuous brake application can overheat the brakes and reduce their effectiveness.*
- *Riding with your foot resting on the brake pedal or your hand on the brake lever may actuate the brake light, giving a false indication to other drivers. It may also overheat the brakes, reducing effectiveness.*

# OPERATION

---

## **System Description and Additional Operation — Standard Model:**

The non-CBS/ABS/TCS model is equipped with separate hydraulic systems for the front brakes and rear brakes, like any conventional motorcycle.

Remember, extreme braking may cause either wheel to lock, reducing control of the motorcycle.

## **System Description and Additional Operation — CBS/ABS/TCS Model:**

The CBS/ABS/TCS model is equipped with a Dual Combined Brake System. Operating the front brake lever applies the front brake and a portion of the rear brake. Operating the rear brake pedal applies the rear brake and a portion of the front brake. For full braking effectiveness, use both the lever and pedal simultaneously, as you would with a conventional motorcycle braking system.

This model is also equipped with an Anti-lock Brake System (ABS) designed to help prevent wheel lock up during hard braking or during braking on uneven or other poor surfaces while running straight. Although the wheel may not lock up — if you are braking too hard in a turn the motorcycle can still lose traction, causing a loss of control.

In some situations, a motorcycle with ABS may require a longer stopping distance to stop on loose or uneven surfaces than an equivalent motorcycle without ABS.

ABS cannot make up for road conditions, bad judgment, or improper operation of the brakes. It is still your responsibility to ride at reasonable speeds for weather, road surface, and traffic conditions, and to leave a margin of safety.

ABS is self-checking and always on.

## NOTE

- ABS may be activated by riding over a sharp drop or rise in the road level.
- It is important to follow the tyre recommendations (see page 31). The ABS computer works by comparing wheelspeed. Non-recommended tyres can affect wheelspeed and may confuse the ABS computer.
- ABS does not function at low speeds (approximately 7 km/h or below).
- ABS does not function if the battery is discharged.

## ABS Indicator Light

Normally, this light comes on when the ignition is turned ON and goes off after starting to ride (see page 15). If there is an ABS problem, the indicator light comes on and remains on — or blinks. The ABS system does not operate when the ABS indicator light is on or blinking.

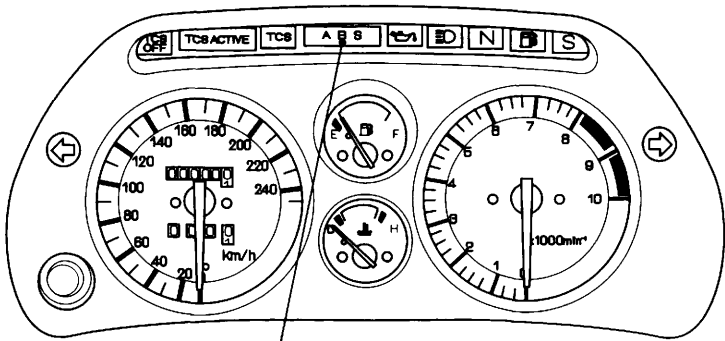

ABS Indicator Light

## OPERATION

---

If the ABS indicator light blinks while riding, stop the motorcycle in a safe place and turn off the engine.

Turn the ignition ON again. The light should come on, and then go off after starting to ride. If it does not go off or if it blinks again, ABS is not functioning, but the brakes still work a Dual Combined Brake System and provide normal stopping ability. However, you should have the system checked by an authorized Honda dealer as soon as possible.

### NOTE

- The ABS indicator light may blink if you turn the rear wheel placing the motorcycle upright on the stand. This is normal. Turn the ignition OFF to stop the blinking.

### CAUTION

- ***Two red bulbs are used for the ABS indicator light. Be sure that both bulbs light when the ignition is ON. If either or both bulbs fail to light, See your authorized Honda dealer.***

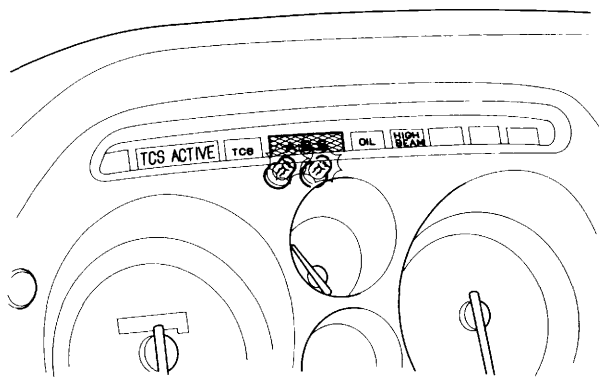

---

## ABS/TCS Indicator Light Switch

To dim the intensity of the blinking ABS Indicator Light, push the ABS/TCS Indicator Light Switch.

**⚠ WARNING**

- ***Do not operate the switch while riding the motorcycle. Operating the motorcycle with one or both hands away from the handlebar/controls may result in a loss of vehicle control.***

ABS/TCS Indicator Light Switch

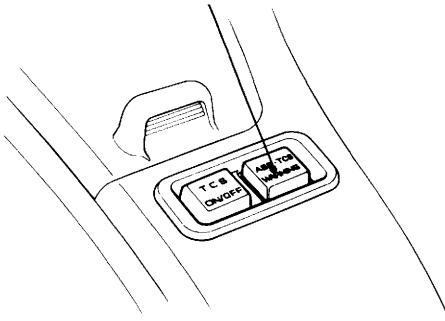

# OPERATION

## TRACTION CONTROL SYSTEM (TCS) (For model equipped with CBS/ABS/TCS)

The Traction Control System (TCS) assists you in maintaining traction while accelerating on slippery surfaces by regulating the engine's power output when it senses the rear wheel starting to lose traction.

TCS automatically turns on when the ignition is turned ON. You have the option of turning TCS off by using the TCS ON/OFF Switch (see page 59).

Riding with TCS requires no special skills or techniques. TCS does not affect braking and cannot prevent loss of traction if you enter a corner too fast. It is still your responsibility to ride at reasonable speeds for weather, road surface, and traffic conditions, and to leave a margin of safety.

When riding on loose, slippery, or uneven surfaces, you may notice the engine does not respond to the throttle in the same way it usually does. This is a sign that TCS is activated and operating. The TCS Activation Light will flash on to signal you.

### NOTE:

- Engine intake and exhaust noise may change when the TCS is active.
- TCS may be activated by riding over a sharp drop or rise in the road level.

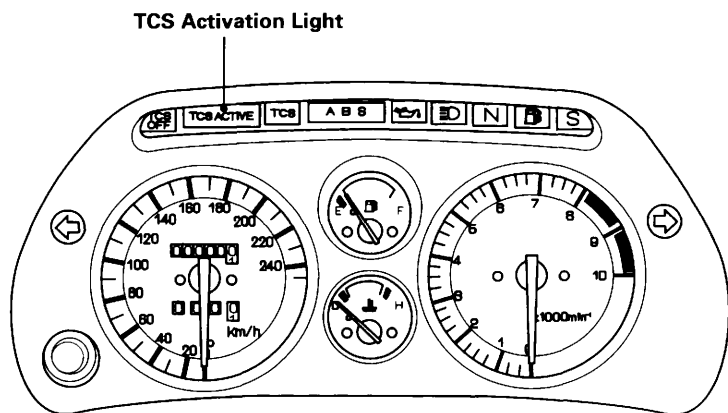

## TCS ON/OFF Switch

This switch lets you turn TCS on or off.

Before you begin riding or while parked, you may choose to turn TCS off by pressing the TCS ON/OFF Switch. (You cannot turn TCS off if the motorcycle is moving.) The TCS OFF Indicator comes on. If TCS is off, turn it on by pressing the switch.

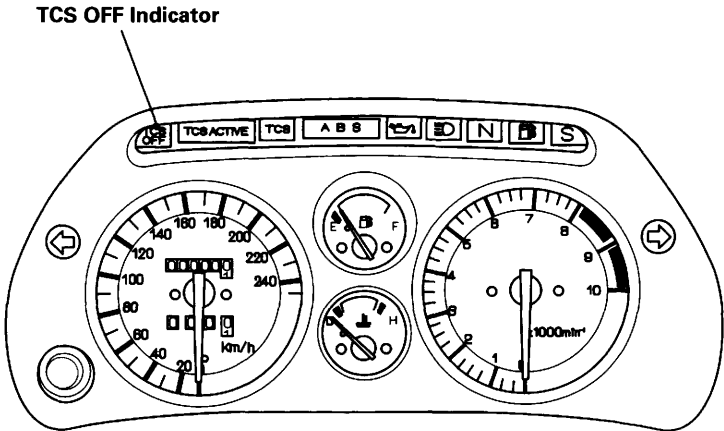
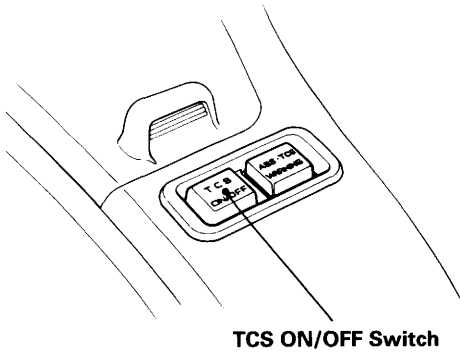

# OPERATION

---

## TCS Indicator Light

Normally, this light comes on when the ignition is turned ON and goes off after starting to ride (see page 15). If there is a TCS problem, the indicator light comes on and remains on — or blinks. The system does not operate when the TCS indicator light is on or blinking.

If the TCS indicator light blinks while riding, stop the motorcycle in a safe place and turn off the engine.

Turn the ignition ON again. The light should come on, and then go off after starting to ride. If it does not go off or if it blinks again, TCS is not functioning. You can drive the motorcycle without TCS. However, have the system checked by an authorized Honda dealer as soon as possible.

### NOTE:

- When the TCS indicator light blinks, TCS is automatically disabled and the TCS OFF indicator turns on.
- The TCS indicator light may blink if you turn the rear wheel placing the motorcycle upright on the stand. This is normal. Turn the ignition OFF to stop the blinking.

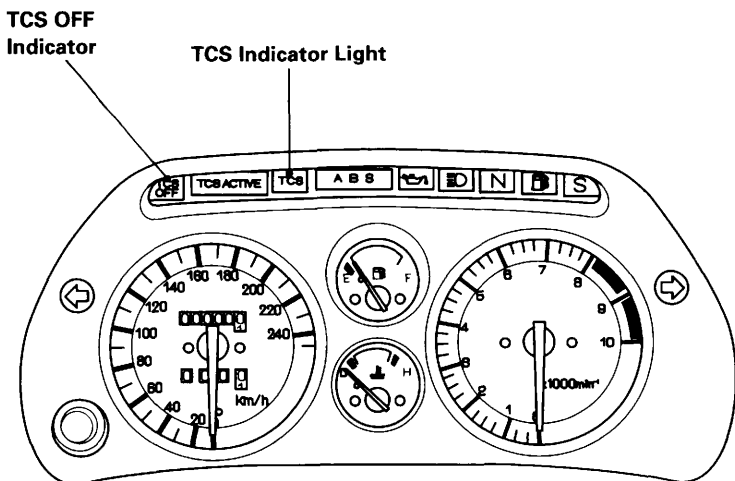

---

## ABS/TCS Indicator Light Switch

To turn off the blinking TCS Indicator Light, push the ABS/TCS Indicator Light Switch.

**⚠ WARNING**

- ***Do not operate the switch while riding the motorcycle. Operating the motorcycle with one or both hands away from the handlebar/controls may result in a loss of vehicle control.***

**NOTE:**

- The TCS OFF indicator remains ON after the TCS indicator light is off.

**ABS/TCS Indicator Light Switch**

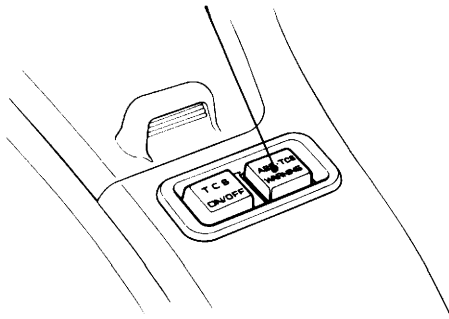

# OPERATION

---

## PARKING

1. After stopping the motorcycle, shift the transmission into neutral, turn the ignition switch OFF and remove the key.
2. Use the side or center stand to support the motorcycle while parked.

## CAUTION:

- ***Park the motorcycle on firm, level ground to prevent it from falling over.***
3. Lock the steering to help prevent theft (page 37).

---

## ANTI-THEFT TIPS

1. Always lock the steering and never leave the key in the ignition switch. This sounds simple but people do forget.
2. Be sure the registration information for your motorcycle is accurate and current.
3. Park your motorcycle in a locked garage whenever possible.
4. Use an additional anti-theft device of good quality.

When you park your motorcycle, we recommend that you secure it by using the securing point and a commercially available chain and lock or equivalent.

5. Put your name, address, and phone number in this Owner's Manual and keep it on your motorcycle at all times. Many times stolen motorcycles are identified by information in the Owner's Manuals that are still with them.

NAME: \_\_\_\_\_

ADDRESS: \_\_\_\_\_

\_\_\_\_\_

\_\_\_\_\_

PHONE NO: \_\_\_\_\_

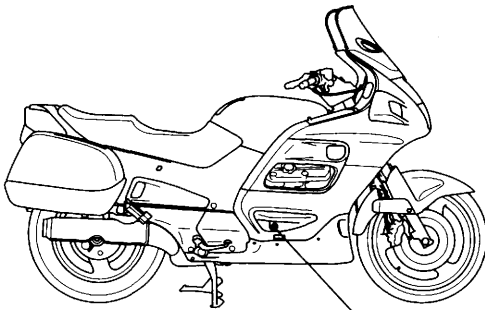

**Securing Point**

## **MAINTENANCE**

---

- The Required Maintenance Schedule specifies how often you should have your motorcycle served, and what things need attention. It is essential that your motorcycle be served as scheduled to retain its high level of safety, dependability, and emission control performance.
- These instructions are based on the assumption that the motorcycle will be used exclusively for its designed purpose. Sustained high speed operation or operation in unusually wet or dusty conditions will require more frequent service than specified in the MAINTENANCE SCHEDULE. Consult your authorized Honda dealer for recommendations applicable to your individual needs and use.

## MAINTENANCE SCHEDULE

Perform the Pre-ride Inspection (page 47) at each scheduled maintenance period.

I : INSPECT AND CLEAN, ADJUST, LUBRICATE OR REPLACE IF NECESSARY

C: CLEAN R: REPLACE A: ADJUST L: LUBRICATE

The following Maintenance Schedule specifies all maintenance required to keep your motorcycle in peak operating condition. Maintenance work should be performed in accordance with standards and specifications of Honda by properly trained and equipped technicians. Your authorized Honda dealer meets all of these requirements.

ITEM	FREQUENCY	WHICHEVER → COMES FIRST ↓ NOTE	ODOMETER READING (NOTE 1)								Refer to page
			×1,000 km	1	6	12	18	24	30	36	
			×1,000 mi	0.6	4	8	12	16	20	24	
* FUEL LINE					I		I		I	—	
* THROTTLE OPERATION					I		I		I	—	
* CARBURETOR CHOKE					I		I		I	—	
AIR CLEANER	NOTE 2					R			R	78	
SPARK PLUGS				I	R	I	R	I	R	80	
* VALVE CLEARANCE							I			—	
ENGINE OIL			R		R		R		R	75	
ENGINE OIL FILTER			R		R		R		R	75	
* CARBURETOR SYNCHRONIZATION			I		I		I		I	—	
* ENGINE IDLE SPEED			I	I	I	I	I	I	I	—	
RADIATOR COOLANT	NOTE 3				I		I		R	22	
* COOLING SYSTEM					I		I		I	—	
* SECONDARY AIR SUPPLY SYSTEM	NOTE 4				I		I		I	—	
** TIMING BELT									EVERY 100.000 km (60.000 mi) I EVERY 150.000 km (90.000 mi) R	—	

# MAINTENANCE

ITEM	FREQUENCY	WHICHEVER → COMES FIRST ↓ NOTE	ODOMETER READING (NOTE 1)								Refer to page
			×1,000 km	1	6	12	18	24	30	36	
			×1,000 mi	0.6	4	8	12	16	20	24	
FINAL DRIVE OIL					I		I			R	29, 83
BRAKE FLUID		NOTE 3			I	I	R	I	I	R	18
BRAKE PAD WEAR					I	I	I	I	I	I	93
BRAKE SYSTEM				I		I		I		I	18, 94
* BRAKE LIGHT SWITCH						I		I		I	—
* HEADLIGHT AIM						I		I		I	—
CLUTCH SYSTEM						I		I		I	21
CLUTCH FLUID		NOTE 3			I	I	R	I	I	R	21
SIDE STAND						I		I		I	95
* SUSPENSION						I		I		I	—
* NUTS, BOLTS, FASTENERS				I		I		I		I	—
** WHEELS/TYRES						I		I		I	—
** STEERING HEAD BEARINGS				I		I		I		I	—

\* SHOULD BE SERVICED BY AN AUTHORIZED HONDA DEALER, UNLESS THE OWNER HAS PROPER TOOLS AND SERVICE DATA AND IS MECHANICALLY QUALIFIED. REFER TO THE OFFICIAL HONDA SHOP MANUAL.

\*\* IN THE INTEREST OF SAFETY, WE RECOMMEND THESE ITEMS BE SERVICED ONLY BY AN AUTHORIZED HONDA DEALER.

Honda recommends that your authorized Honda dealer should road test your motorcycle after each periodic maintenance is carried out.

NOTES: 1. At higher odometer readings, repeat at the frequency interval established here.

2. Service more frequently when riding in unusually wet or dusty areas.

3. Replace every 2 years, or at indicated odometer interval, whichever comes first. Replacement requires mechanical skill.

4. Switzerland type only.

---

## TOOL KIT

The tool kit is in the right fairing pocket. Open the right fairing pocket (page 43). Some roadside repairs, minor adjustments and parts replacement can be performed with the tools contained in the kit.

- Spark plug wrench
- 10 × 12 mm Box end wrench
- 14 mm Box end wrench
- 24 mm Box end wrench
- 27 mm Box end wrench
- 8 mm Open end wrench
- 10 × 12 mm Open end wrench
- 14 × 17 mm Open end wrench
- Pliers
- Screwdriver handle
- Screwdriver
- Pin spanner
- Pin spanner grip
- 5 mm Hex wrench
- 6 mm Hex wrench
- Feeler gauge 0.5 mm (Model equipped with CBS/ABS/TCS)
- Tool bag

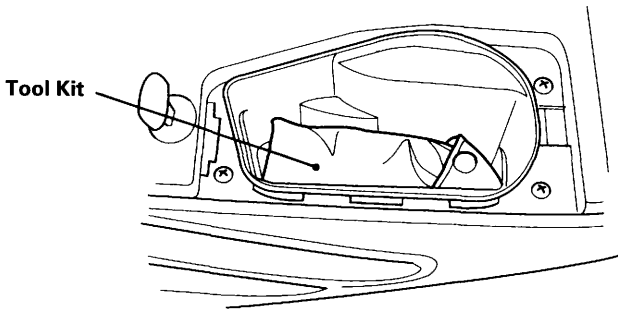

# MAINTENANCE

---

## SERIAL NUMBERS

The frame and engine serial numbers are required when registering your motorcycle. They may also be required by your dealer when ordering replacement parts.

Record the numbers here for your reference.

The frame number is stamped on the right side of the steering head.

The engine number is stamped on the rear of the lower crankcase behind the oil pan.

## COLOUR LABEL

The colour label is attached to the frame under the seat. It is helpful when ordering replacement parts. Record the colour and code here for your reference.

FRAME NO. \_\_\_\_\_

ENGINE NO. \_\_\_\_\_

COLOUR \_\_\_\_\_

CODE \_\_\_\_\_

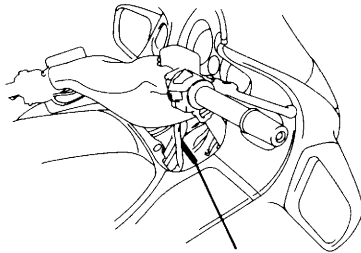

Frame Number

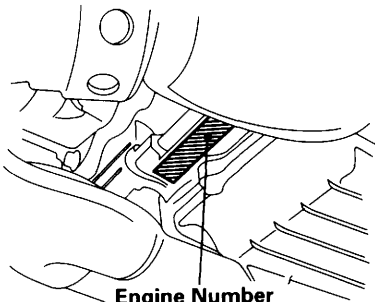

Engine Number

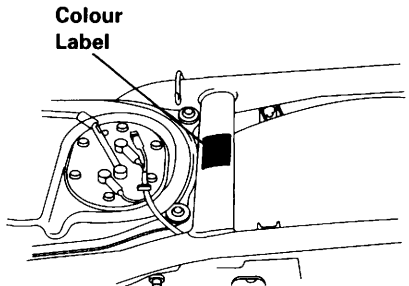

Colour Label